

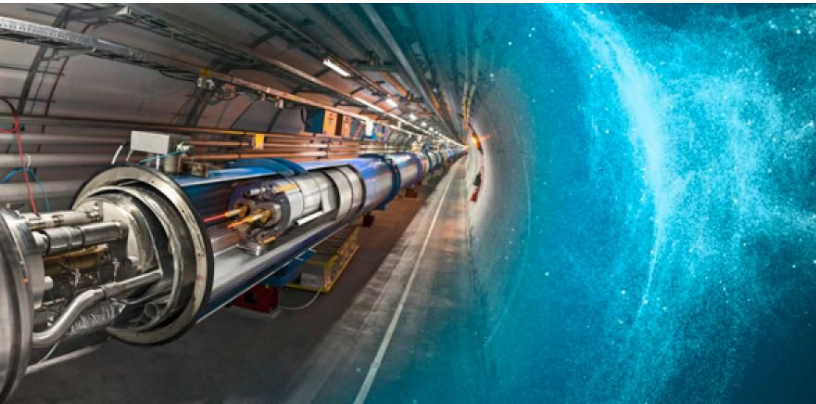

The Spin Physics Detector at **NICA**

Reham El-Kholy (Cairo University) on behalf of *the SPD collaboration*
relkholy@sci.cu.edu.eg



**First Pan-African Astro-Particle
and Collider Physics Workshop**

21-23 March 2022

NICA - Nuclotron-based Ion Collider fAcility

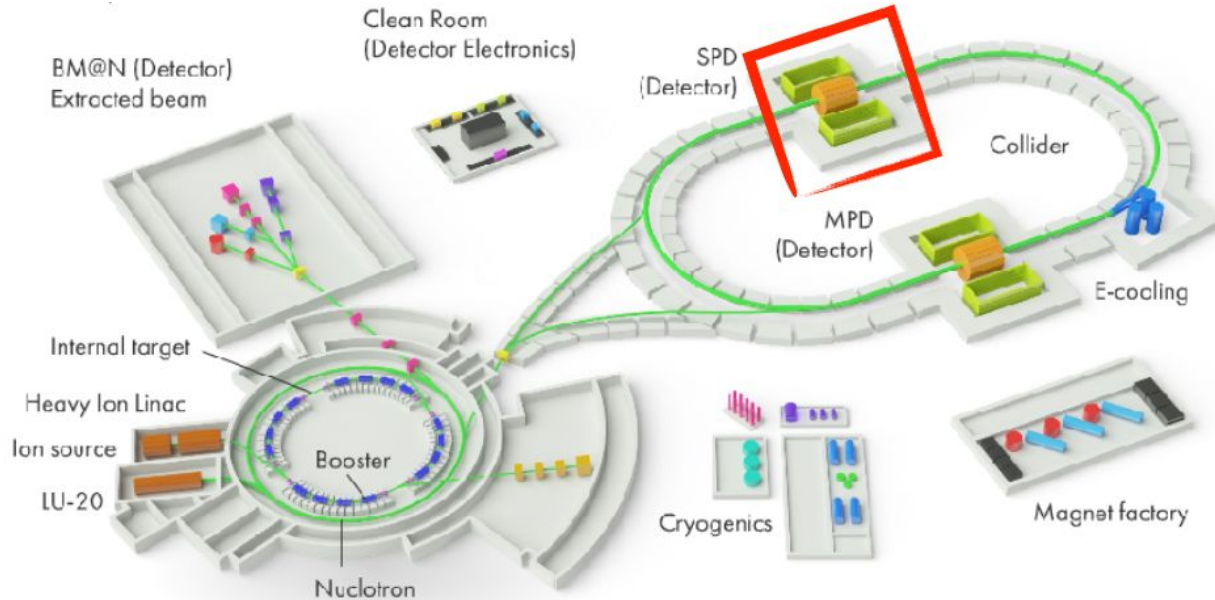

Proton and
deuteron beams

For pp collisions

$\sqrt{s} \leq 27 \text{ GeV}$

$L \leq 10^{32} \text{ cm}^{-2} \text{ s}^{-1}$

NICA - Nuclotron-based Ion Collider fAcility

$$p^\uparrow p^\uparrow : \sqrt{s} \leq 27 \text{ GeV}$$

$$d^\uparrow d^\uparrow : \sqrt{s} \leq 13.5 \text{ GeV}$$

$$d^\uparrow p^\uparrow : \sqrt{s} \leq 19 \text{ GeV}$$

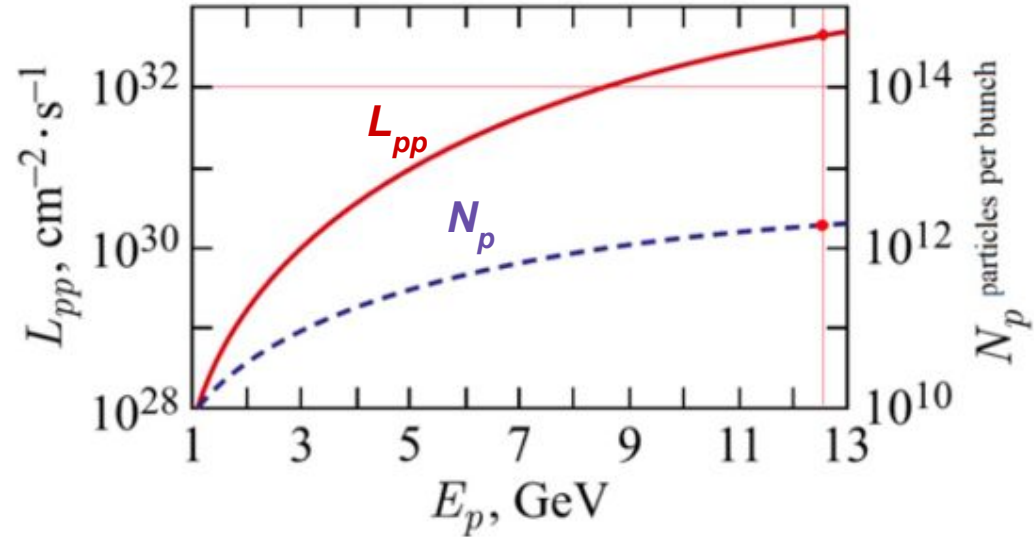

NICA site at JINR, Dubna

2017



Now



Preliminary timeline

Creating of polarized infrastructure

Upgrade of polarized infrastructure

2023

2026

2028

2030

2032



SPD construction

1st stage
of operation

SPD upgrade

2nd stage
of operation

The SPD Physics Program

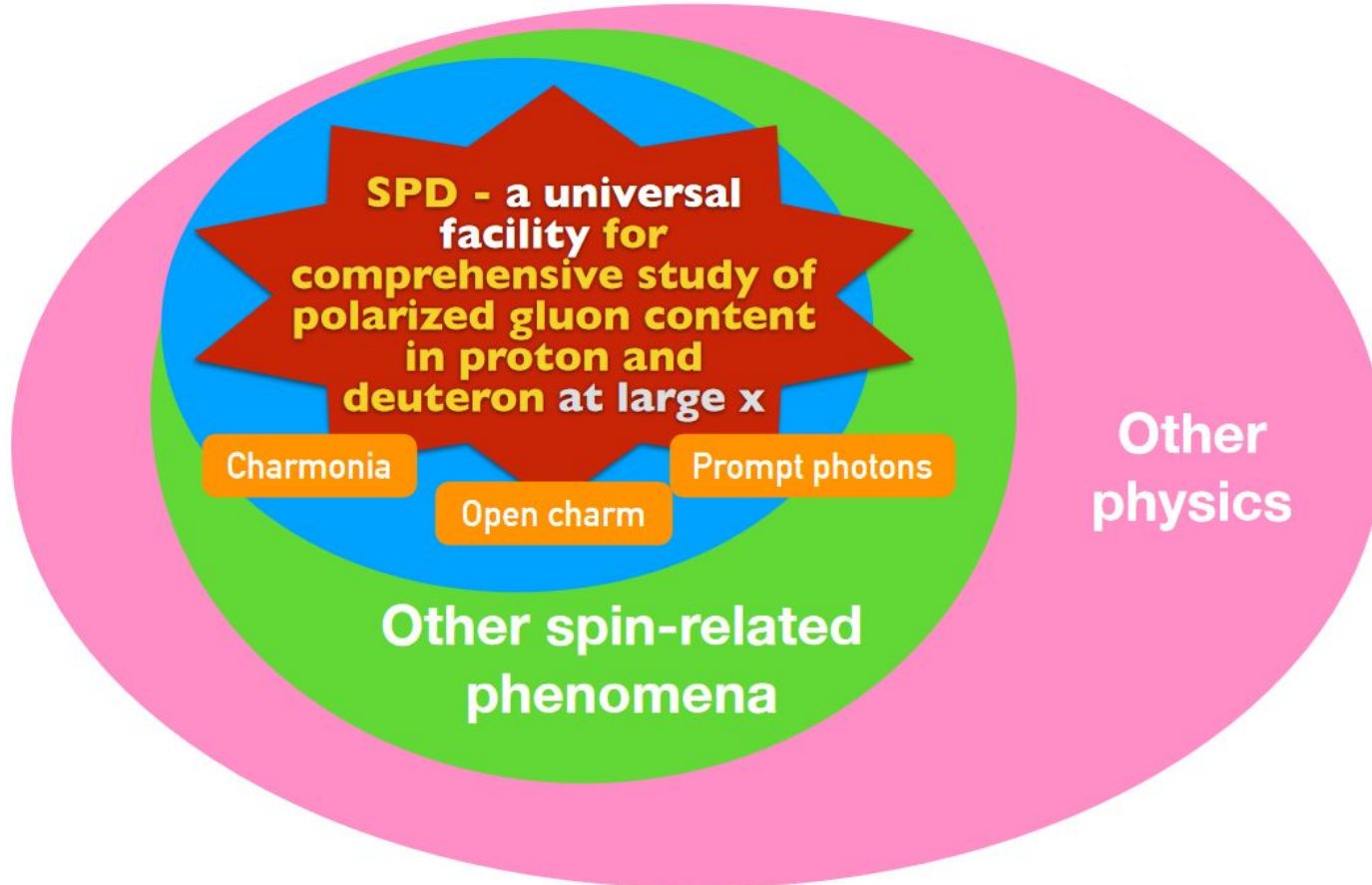



<https://doi.org/10.1016/j.pnnp.2021.103858>



 Springer Link

Published: 02 December 2021

Possible Studies at the First Stage of the NICA Collider Operation with Polarized and Unpolarized Proton and Deuteron Beams

[V. V. Abramov](#), [A. Aleshko](#), [V. A. Baskov](#), [E. Boos](#), [V. Bunichev](#), [O. D. Dalkarov](#), [R. El-Kholy](#), [A. Galoyan](#), [A. V. Guskov](#), [V. T. Kim](#), [E. Kokoulina](#), [I. A. Koop](#), [B. F. Kostenko](#), [A. D. Kovalenko](#), [V. P. Ladygin](#), [A. B. Larionov](#), [A. I. L'vov](#), [A. I. Milstein](#), [V. A. Nikitin](#), [N. N. Nikolaev](#), [A. S. Popov](#), [V. V. Polyanskiy](#), [J.-M. Richard](#), [S. G. Salnikov](#), [A. A. Shavrin](#), [P. Yu. Shatunov](#), [Yu. M. Shatunov](#), [O. V. Selyugin](#), [M. Strikman](#), [E. Tomasi-Gustafsson](#), [V. V. Uzhinsky](#), [Yu. N. Uzikov](#) , [Qian Wang](#), [Qiang Zhao](#) & [A. V. Zelenov](#) — Show fewer authors

Physics of Particles and Nuclei **52**, 1044–1119 (2021) | [Cite this article](#)

Review

On the physics potential to study the gluon content of proton and deuteron at NICA SPD

[A. Arbuзов](#)^a, [A. Bacchetta](#)^{b, c}, [M. Butenschoen](#)^d, [F.G. Celiberto](#)^{b, c, e, f}, [U. D'Alesio](#)^{g, h}, [M. Deka](#)^a, [I. Denisenko](#)^a, [M.G. Echevarria](#)ⁱ, [A. Efremov](#)^a, [N.Ya. Ivanov](#)^{a, j}, [A. Guskov](#)^{a, k, l, m, n}, [A. Karpishkov](#)^{l, a}, [Ya. Klopov](#)^{a, m}, [B.A. Kniehl](#)^{d, a}, [Kotzinian](#)^{l, o}, [S. Kumano](#)^p, [J.P. Lansberg](#)^q, [Keh-Fei Liu](#)^r, [F. Murgia](#)^h, [M. Nefedov](#)^l, [B. Parsamyan](#)^{a, n, o}, [C. Pisano](#)^{g, h}, [M. Radici](#)^c, [A. Rymbekova](#)^a, [V. Saleev](#)^{l, a}, [A. Shipilova](#)^{l, a}, [Qin-Tao Song](#)^s, [O. Teryaev](#)^a

<https://doi.org/10.1134/S1063779621060022>



Polarized Physics Landscape

In the $p\uparrow p\uparrow$ mode

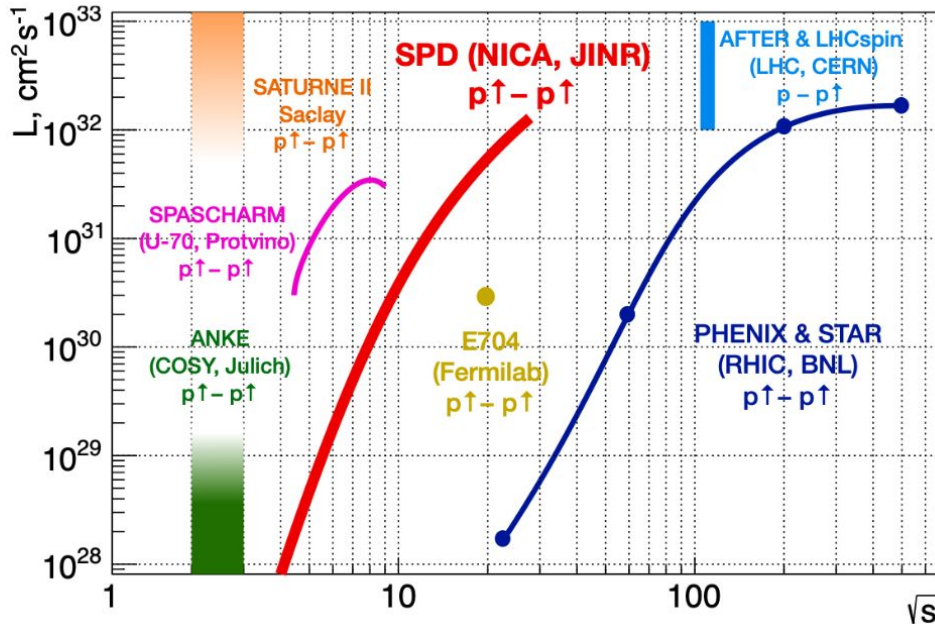

Experimental facility	SPD @NICA	RHIC	EIC	AFTER @LHC	LHCspin
Scientific center	JINR	BNL	BNL	CERN	CERN
Operation mode	collider	collider	collider	fixed target	fixed target
Colliding particles & polarization	$p^\uparrow - p^\uparrow$ $d^\uparrow - d^\uparrow$ $p^\uparrow - d$, $p - d^\uparrow$	$p^\uparrow - p^\uparrow$	$e^\uparrow - p^\uparrow$, d^\uparrow , ${}^3\text{He}^\uparrow$	$p - p^\uparrow$, d^\uparrow	$p - p^\uparrow$
Center-of mass energy $\sqrt{s_{NN}}$, GeV	≤ 27 ($p - p$) ≤ 13.5 ($d - d$) ≤ 19 ($p - d$)	63, 200, 500	20-140 (ep)	115	115
Max. luminosity, $10^{32} \text{ cm}^{-2} \text{ s}^{-1}$	~ 1 ($p - p$) ~ 0.1 ($d - d$)	2	1000	up to ~ 10 ($p - p$)	4.7
Physics run	>2025	running	>2030	>2025	>2025

SPD is unique in the $d\uparrow d\uparrow$ mode

Kinematic Range

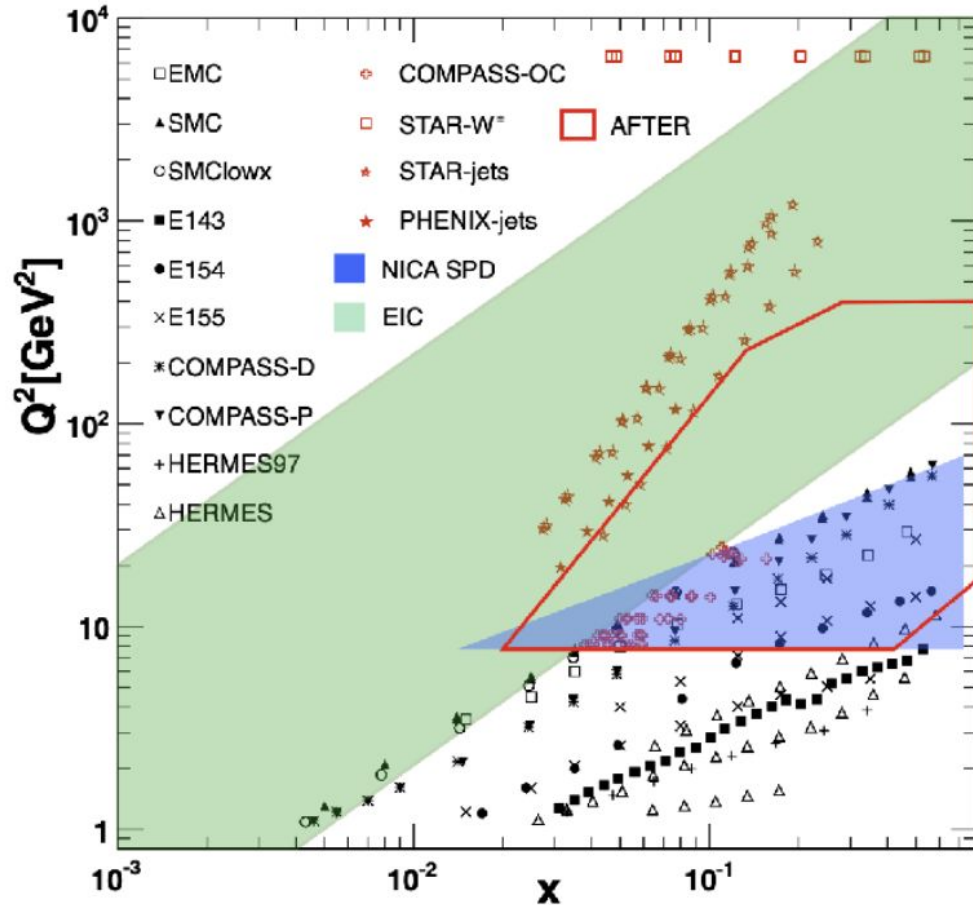

For the **charmonia**,
open-charm and **high-pT**
prompt-photon production

SPD Layout

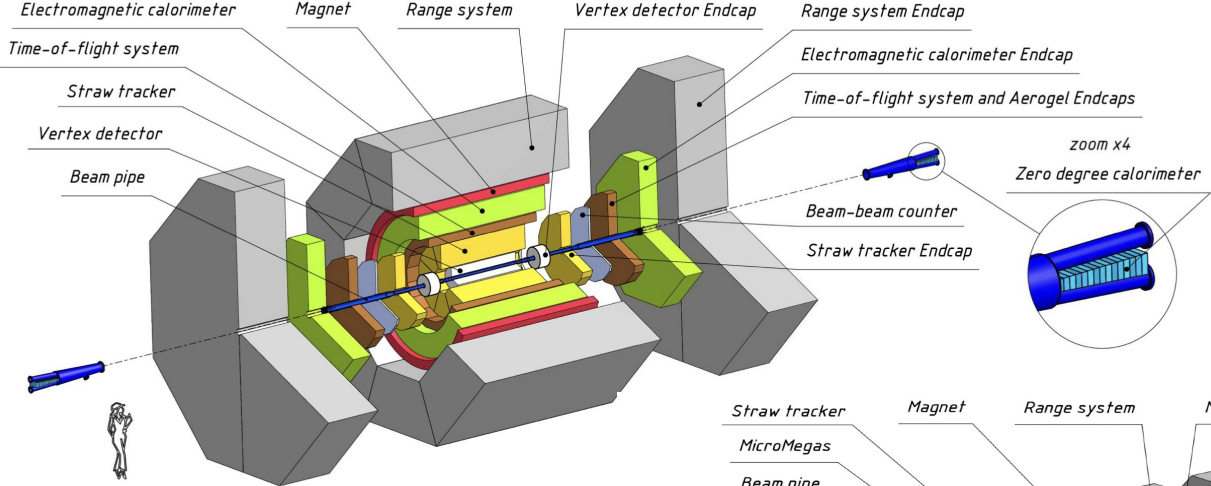

Phase-I →

Running with reduced beam energy and luminosity

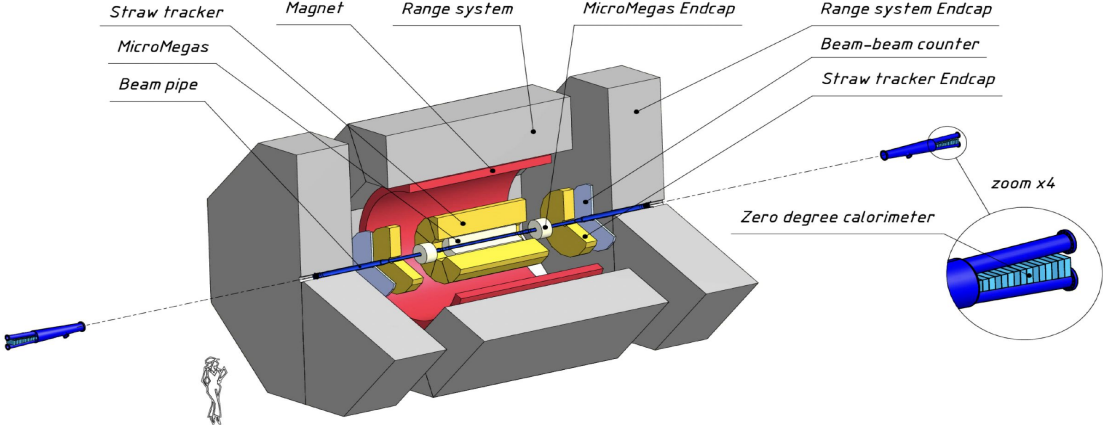

DAQ

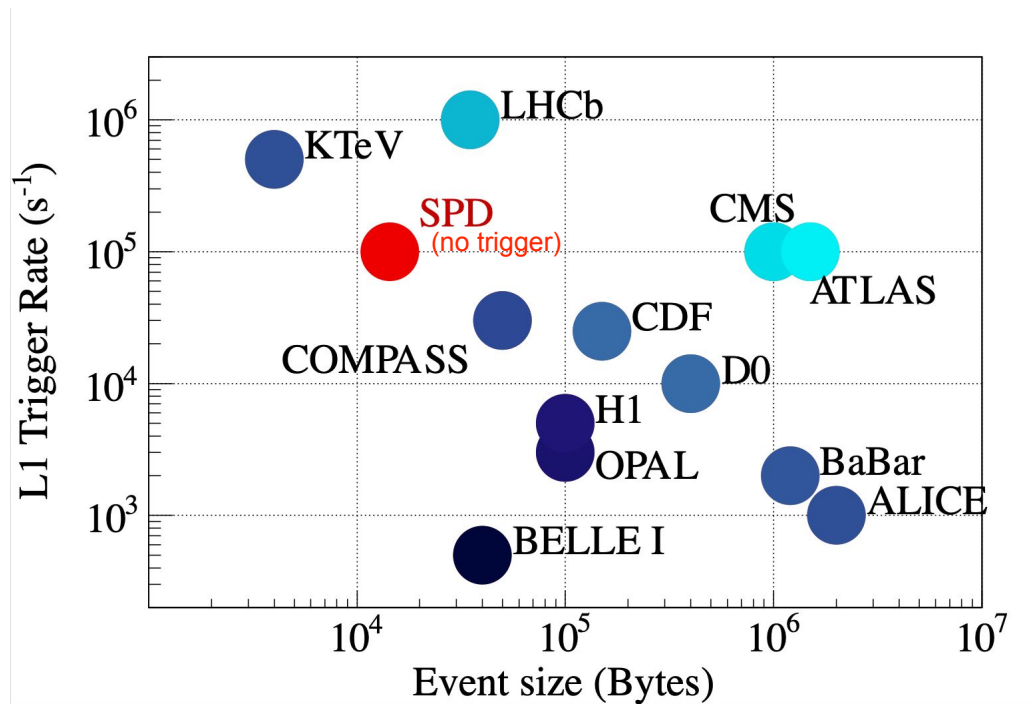

No hardware triggers to avoid possible bias

PID analysis in SPD (π , K, p)

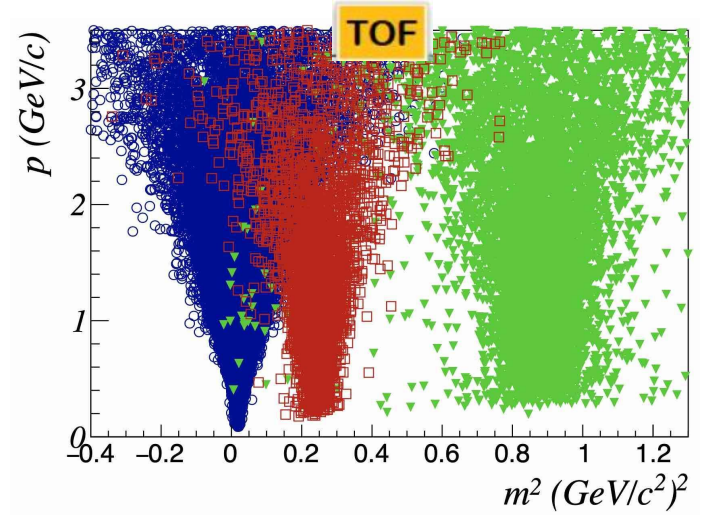
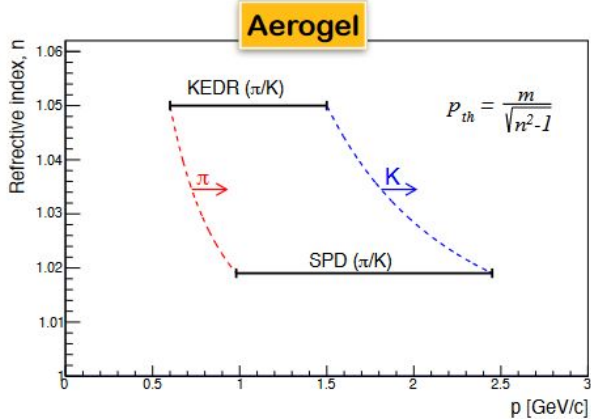
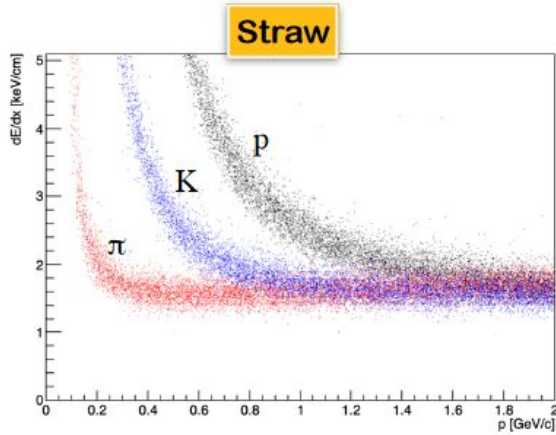

π/K separation

- Momentum up to 0.7 GeV/c to be identified by straw
- Momentum up to 1.5 GeV/c to be identified by straw+TOF
- Tracks with $p > 1.5$ GeV/c to be identified by aerogel

Tentative running plan for the SPD

Physics goal	Required time	Experimental conditions
First stage		
Spin effects in p - p scattering dibaryon resonances	0.3 year	$p_{L,T}$ - $p_{L,T}$, $\sqrt{s} < 7.5$ GeV
Spin effects in p - d scattering, non-nucleonic structure of deuteron, \bar{p} yield	0.3 year	d_{tensor} - p , $\sqrt{s} < 7.5$ GeV
Spin effects in d - d scattering hypernuclei	0.3 year	d_{tensor} - d_{tensor} , $\sqrt{s} < 7.5$ GeV
Hyperon polarization, SRC, ... multiquarks	together with MPD	ions up to Ca
Second stage		
Gluon TMDs, SSA for light hadrons	1 year	p_T - p_T , $\sqrt{s} = 27$ GeV
TMD-factorization test, SSA, charm production near threshold, onset of deconfinement, \bar{p} yield	1 year	p_T - p_T , 7 GeV $< \sqrt{s} < 27$ GeV (scan)
Gluon helicity, ...	1 year	p_L - p_L , $\sqrt{s} = 27$ GeV
Gluon transversity, non-nucleonic structure of deuteron, "Tensor polarized" PDFs	1 year	d_{tensor} - d_{tensor} , $\sqrt{s_{NN}} = 13.5$ GeV or/and d_{tensor} - p_T , $\sqrt{s_{NN}} = 19$ GeV

Antiproton measurement at SPD for Dark Matter search

$$x_R = \frac{E_{\bar{p}}^*}{E_{\bar{p}.max}^*} \quad E_{\bar{p}.max}^* = \frac{s - 8m_p^2}{2\sqrt{s}}$$

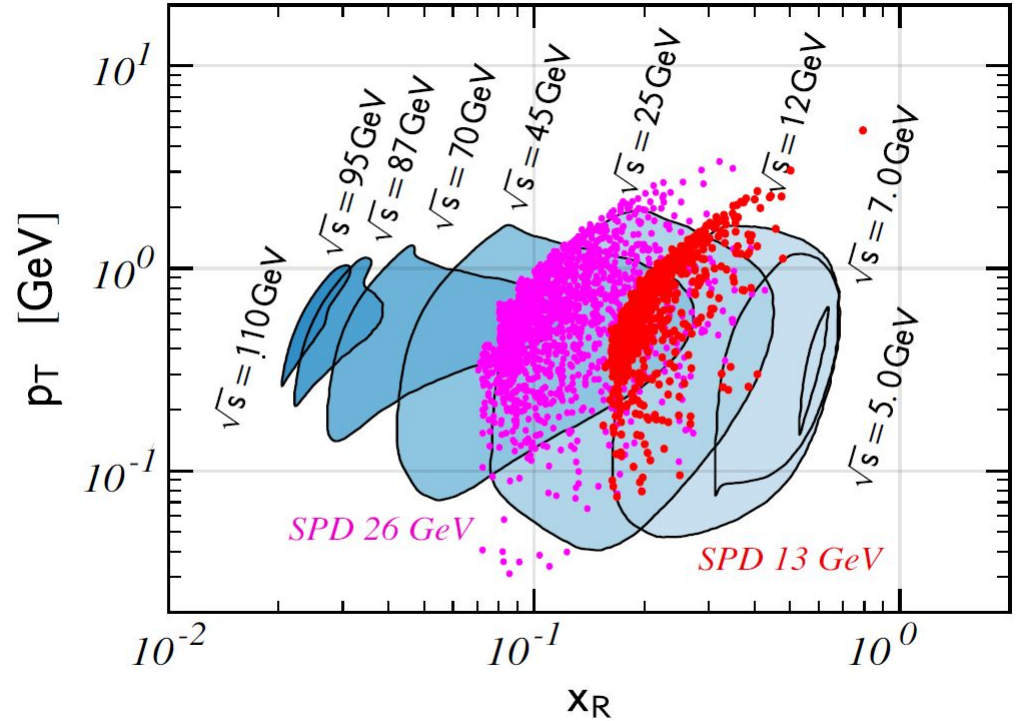
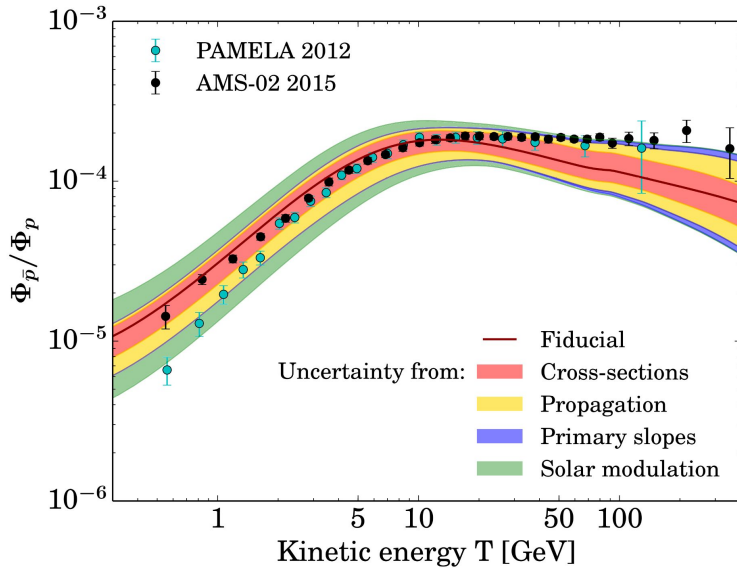

Hyperon decay

SPD pp collisions

$\sqrt{s} = 27$ GeV

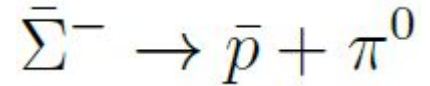
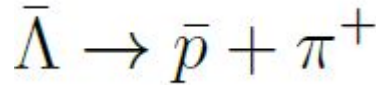
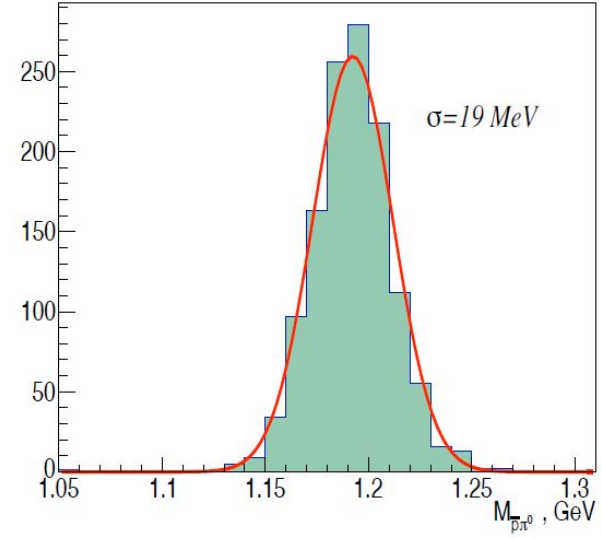
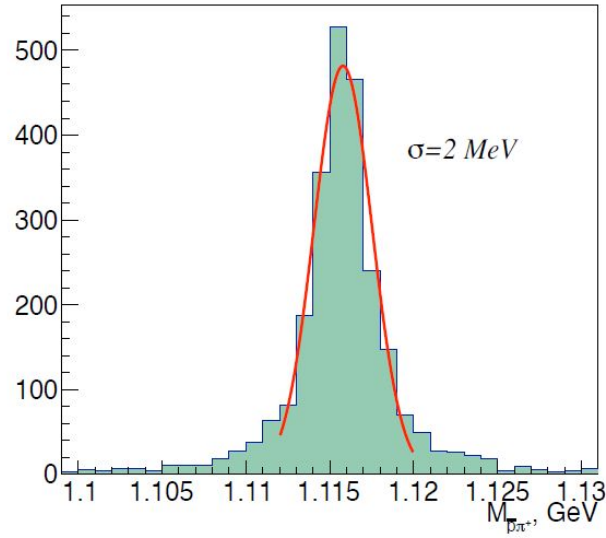
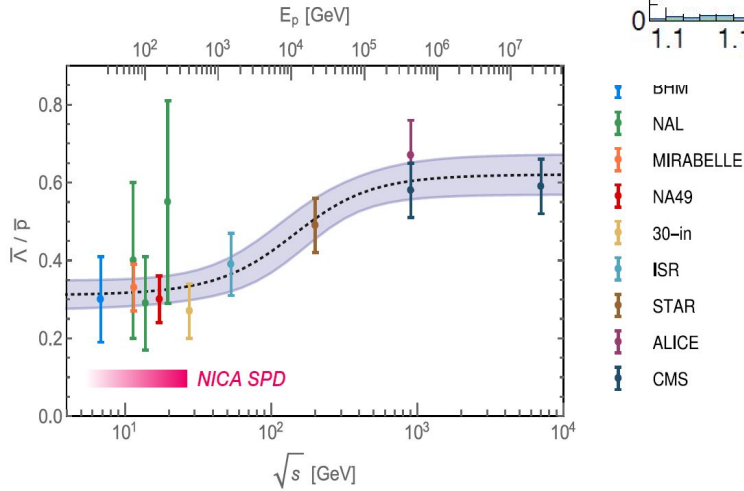

Phys.Part.Nucl.Lett. 18(2), 2021.

Initial stage physics at SPD

- ★ Spin effects in pp- and dd- (quasi)elastic scattering
- ★ Spin effects in hyperon production
- ★ Multiquark correlations (SRC) in deuteron and light nuclei
- ★ Dibaryon resonances
- ★ Hypernucleus production
- ★ Open charm and charmonia production near threshold
- ★ Large-pT hadron production to study diquark structure of proton
- ★ Semi-inclusive large-pT hadron production to study multi-parton scattering
- ★ Antiproton production measurement for astrophysics and BSM search
(continuing to 2nd stage)
- ★ ...

SPD International Collaboration



31 institutes from 14 states, ~300 members



*CDR approved by the **JINR PAC** committee in **January 2022***

*First version of the SPD **TDR** should be presented in 2022*

Summary

- The **Spin Physics Detector** at the NICA collider is a universal facility for global study of polarized and unpolarized gluon content of proton and deuteron; in polarized high-luminosity p-p and d-d collisions at $\sqrt{s} \leq 27$ GeV;
- Comprehensive physics program for the **first period of data taking**;
- The **SPD** is a unique facility for **polarized deuteron** collisions;
- SPD CDR could be found at [arXiv:2102.00442](https://arxiv.org/abs/2102.00442) for more details;
- More information could be found at <http://spd.jinr.ru>.

SPD is open for new ideas and collaborators

Thank You!