



Scintillation detector prototypes for Beam-Beam Counter at NICA SPD

Tishevsky A.V.

LXXI International conference "NUCLEUS – 2021"

22 September 2021

Introduction

The prototype
The equipment
Results



The Spin Physics Detector (SPD)

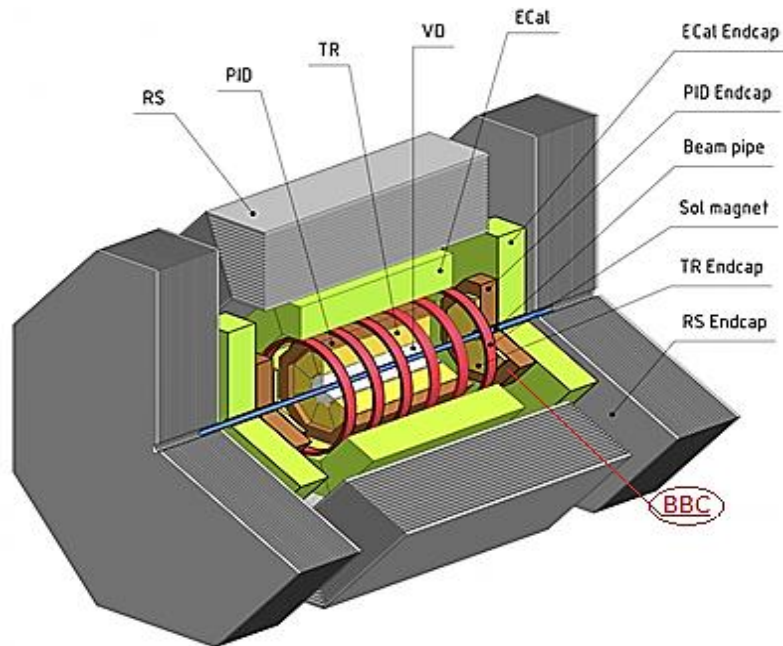

The Beam-Beam Counters (BBC) for SPD

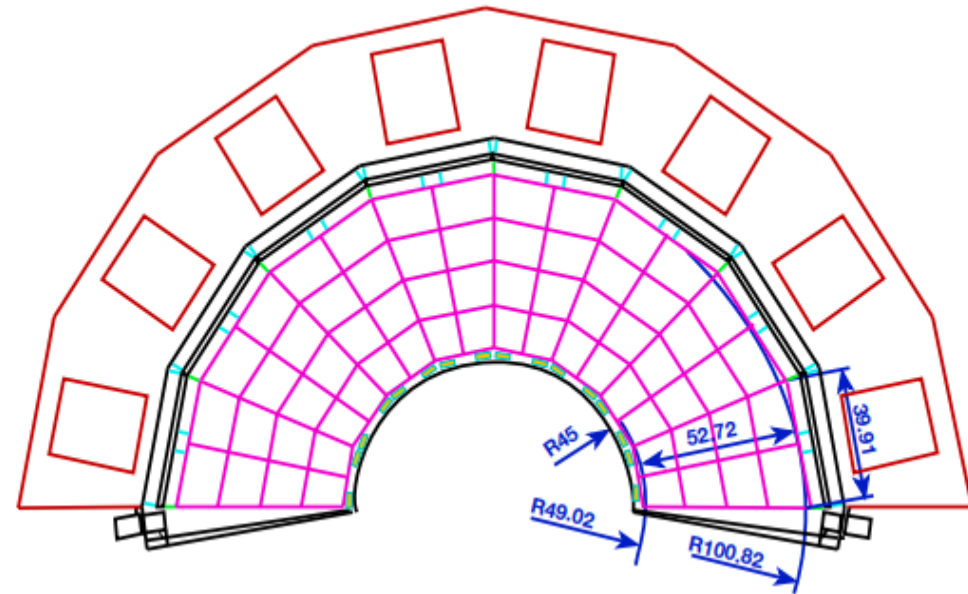

The main purpose is the permanent monitoring of the beam polarization using the azimuthal asymmetry of the inclusive charged particles yield.

Concept:

inner part – microchannel plates based detectors

outer part – high granularity scintillator tiles with SiPM readout

Introduction

The prototype
The equipment
Results

BBC: scintillation tiles

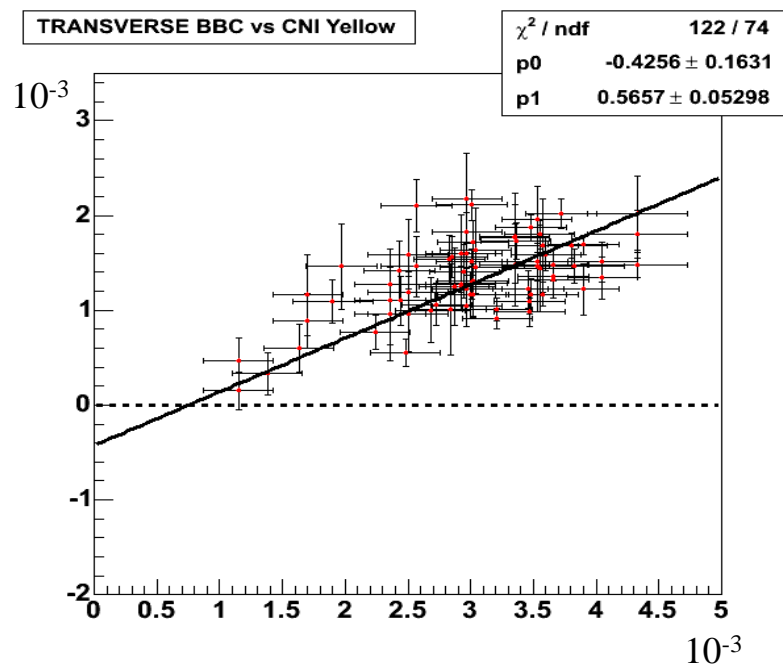

Correlation between CNI polarimeter and STAR BBC asymmetries.

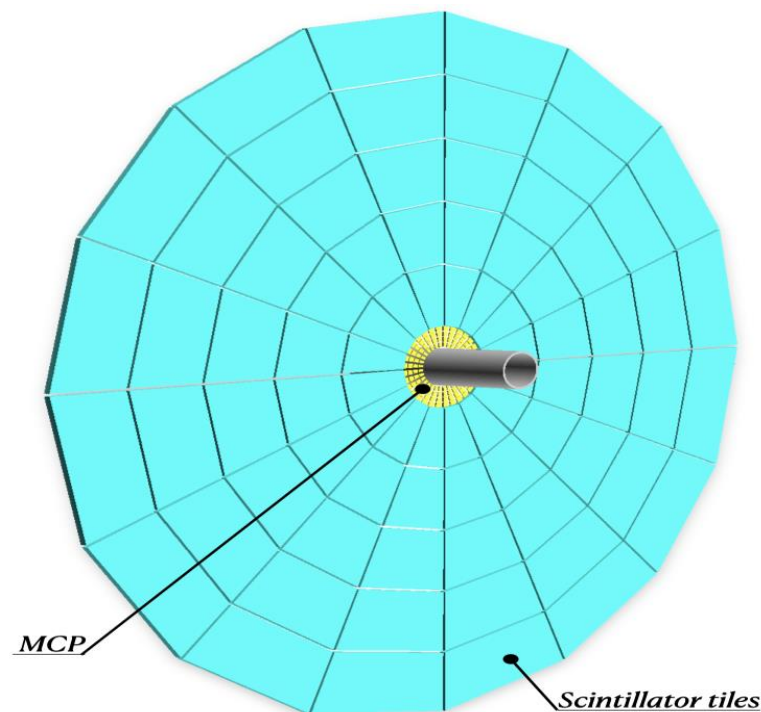

MCP can be used for luminosity estimation and possibly for local polarimetry for pp- and dp- elastic scattering.

Local polarimetry by the analysis of the azimuthal asymmetry in inclusive production of charged particles in forward direction.

1. 2 BBCs: Left and Right

2. Inner part covers 30-60 mrad

– 4 layers *32 sectors = 96 channels MCP

3. Outer part covers 60-500 mrad

– 5-6 layers *16 sectors* 2 SiPM = up to 192 channels

Simulation for polar angle granularity is required!

4. FEE less than 20 W/channel

5. TDC 25ps/channel or better (HPTDC)

6. Holding carbon plastic

7. Needed place about 5 cm in front of PID (TOF)

8. Weight 50-80 kg

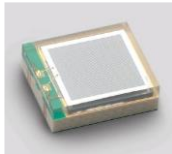

S12572-010P, HAMAMATSU
 (3x3 mm², 10 μm/cell)

Applications:

- ✓ BBC

Advantages	Disadvantages
<ul style="list-style-type: none"> low bias voltage 	<ul style="list-style-type: none"> sensitivity to external temperature changes
<ul style="list-style-type: none"> insensitivity to magnetic fields 	<ul style="list-style-type: none"> some have low radiation hardness
<ul style="list-style-type: none"> compact size 	



1 channel

FEE ToT

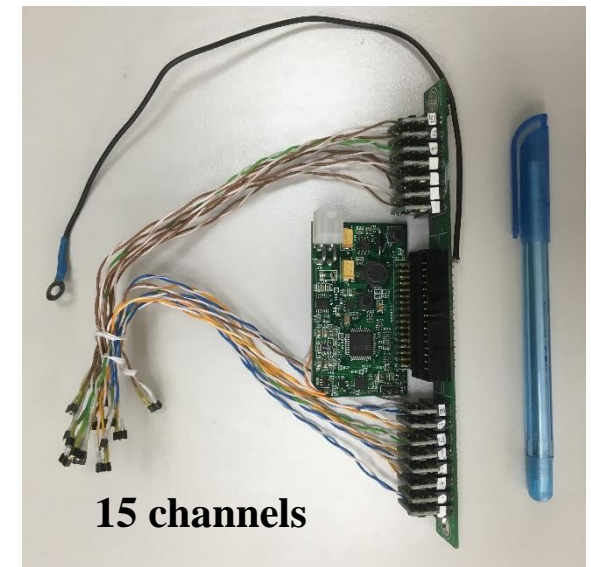

15 channels

FEE DANSS (DANSS experiment)

Properties

- pixel density 10^4 - 2×10^4 mm⁻²,
- size from 1x1 to 6x6 mm²,
- wide dynamic range 5-15000 p.e.,
- photon detection efficiency from ~ 15%,
- high counting rate ~ 10^5 Hz

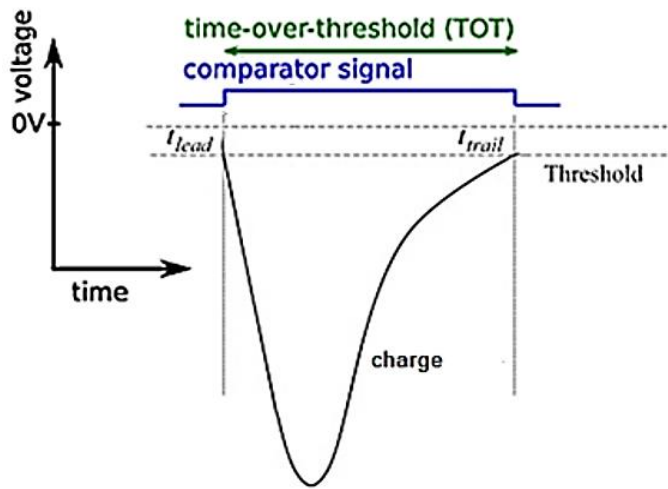

The ToT is a well-known method which allows to measure the energy deposited in the material.



Front-end electronics with ToT technique

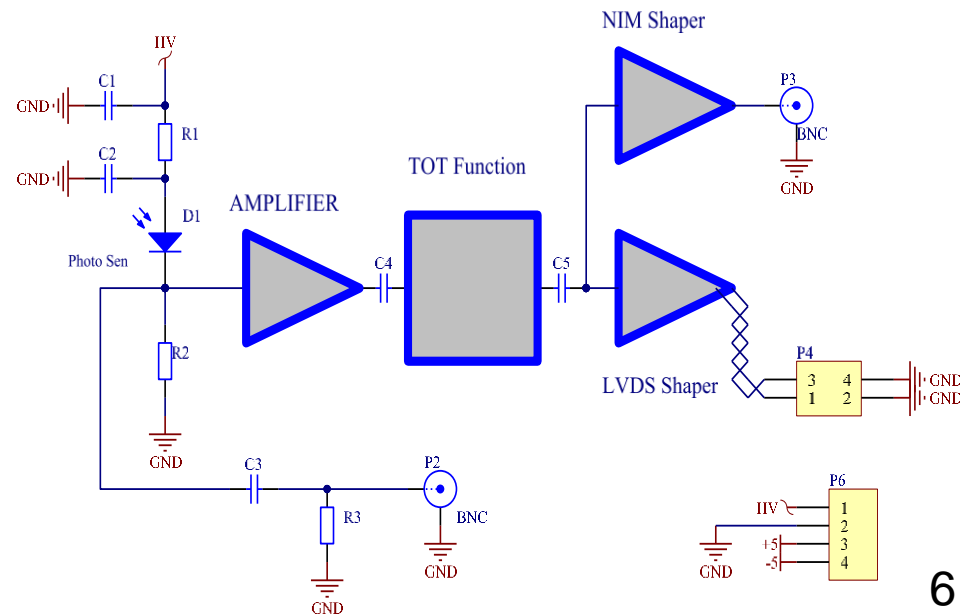

Introduction
 The prototype
The equipment
 Results

The DAQ
The LED



TQDC16
 (16-channel
 time and charge
 digitizer)



TDC32
 (32-channel
 time digitizer)

Schematic view of the LED

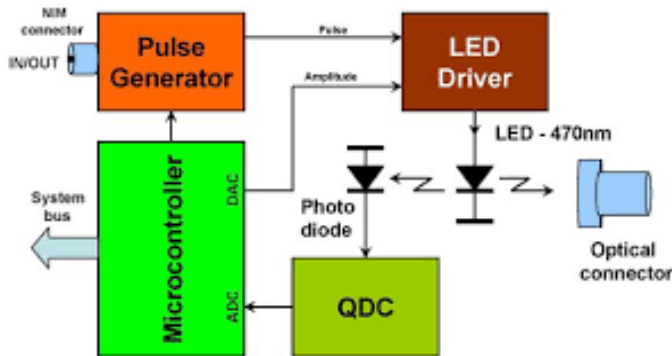

The data were
 accumulated with a
 VME based data-
 acquisition system
 (DAQ)

*Isupov A.Yu. // EPJ Web Conf.
 2019. V.10003. P.204*

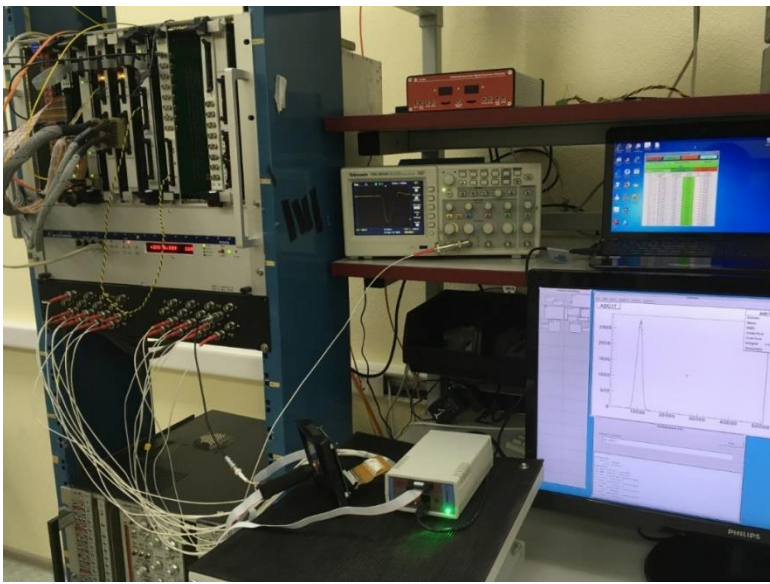
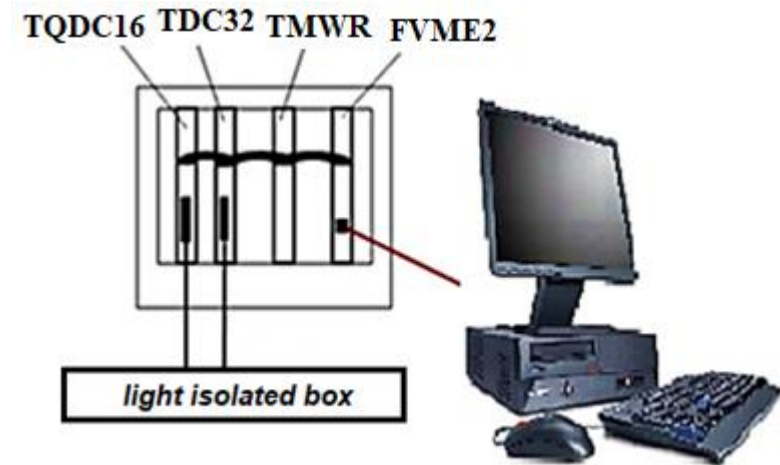

Schematic view of the test

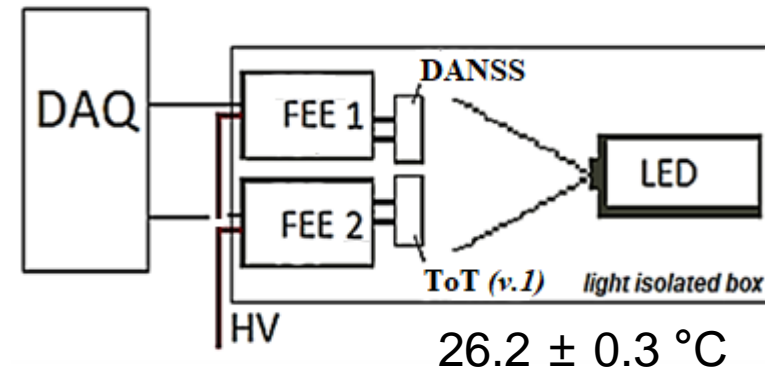

Introduction

The prototype

The equipment

Results

Extracting correction parameters FEE ToT (version №1)

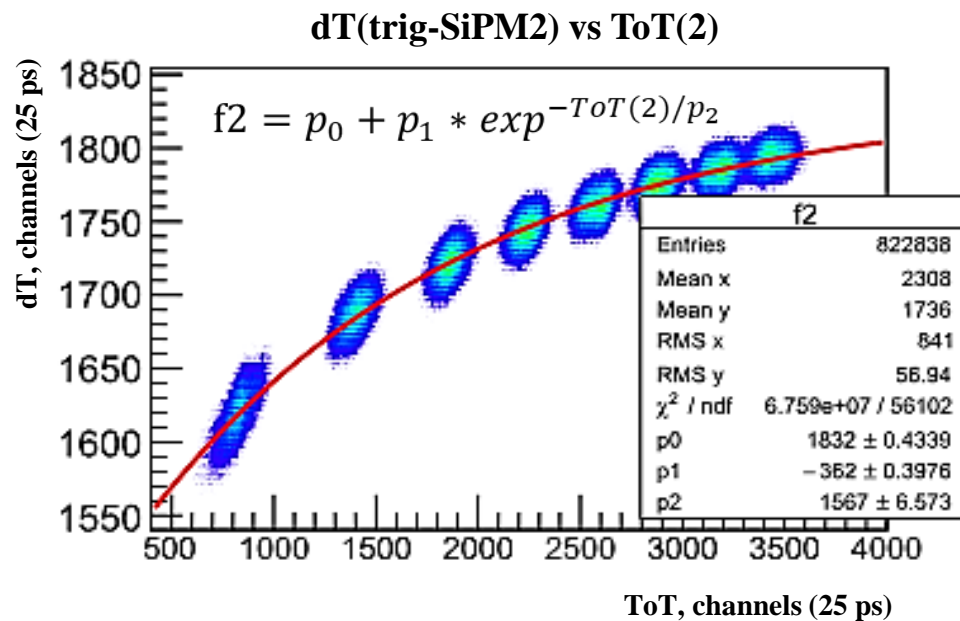
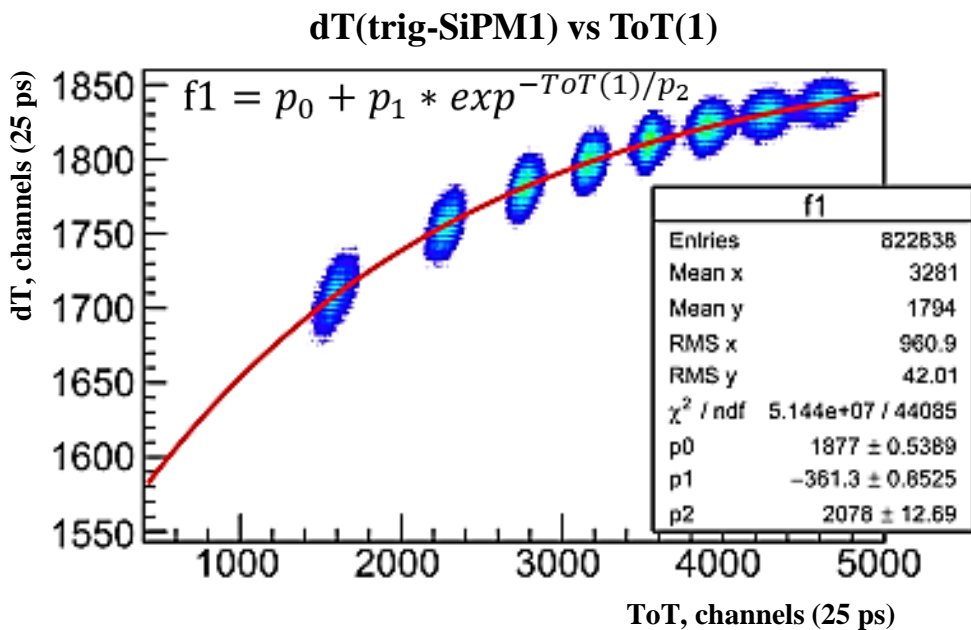
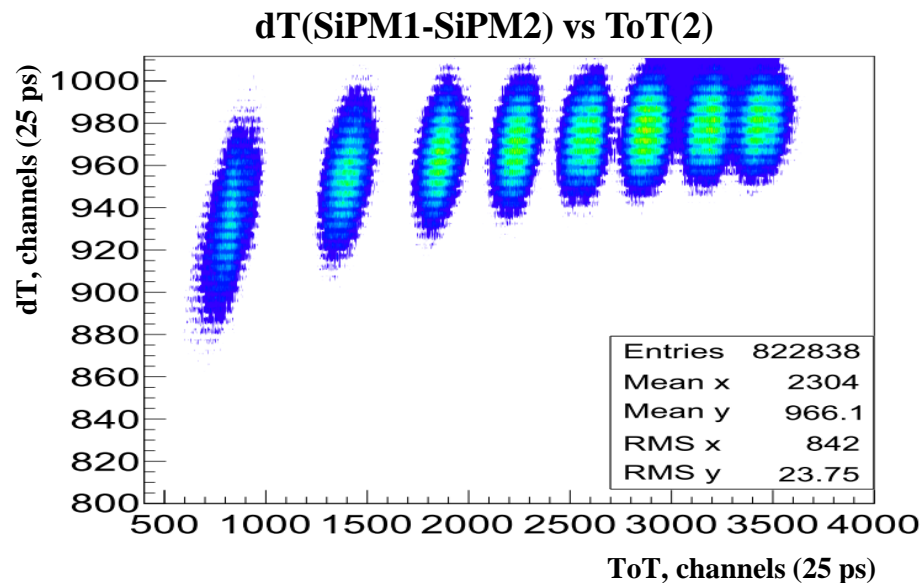
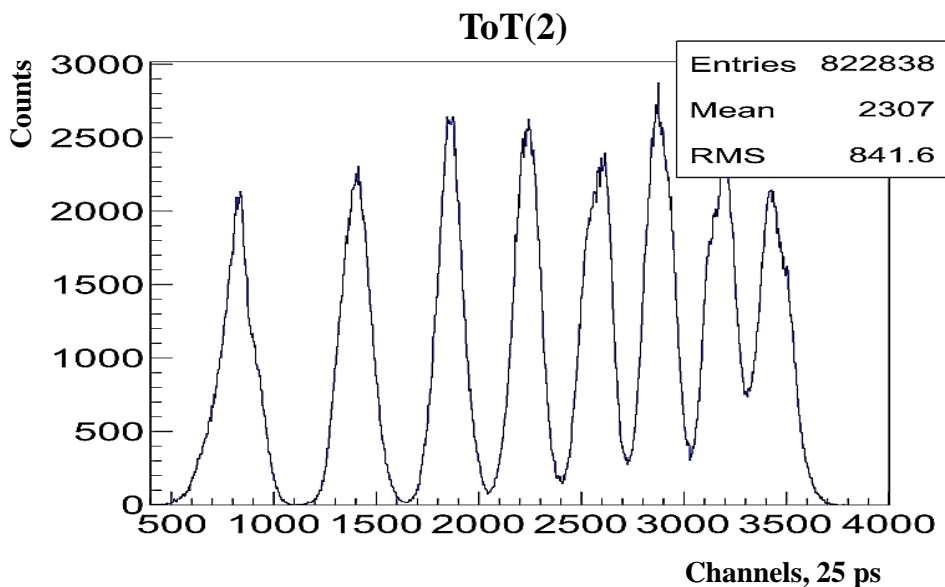

dT(SiPM1-SiPM2) vs ToT(2)

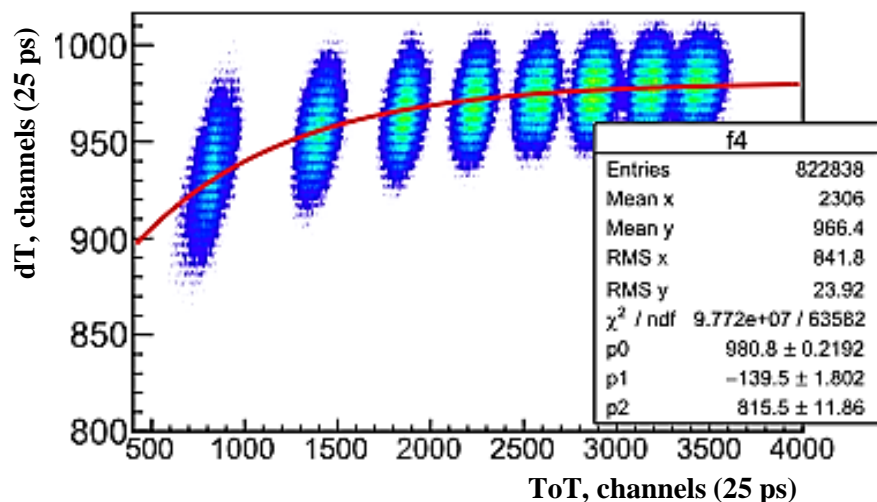

dT(SiPM1-SiPM2)

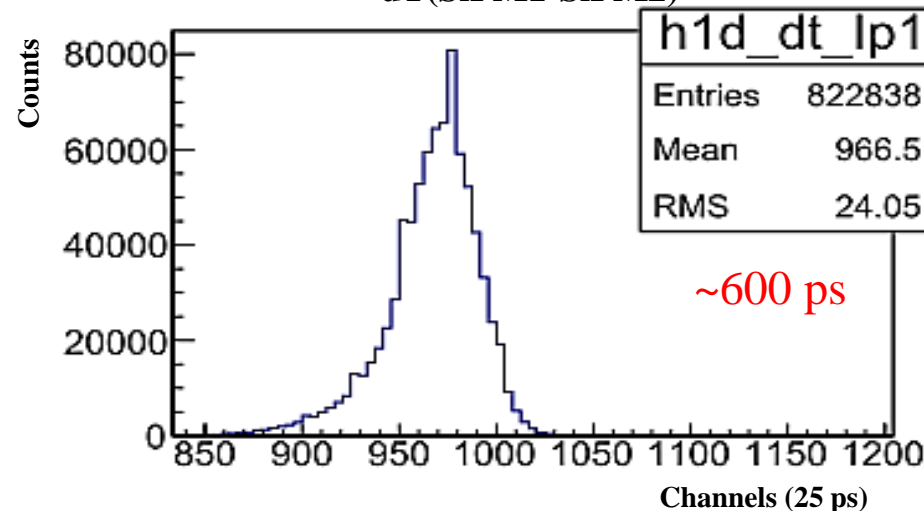

Corrected dT(SiPM1-SiPM2) vs ToT(2)

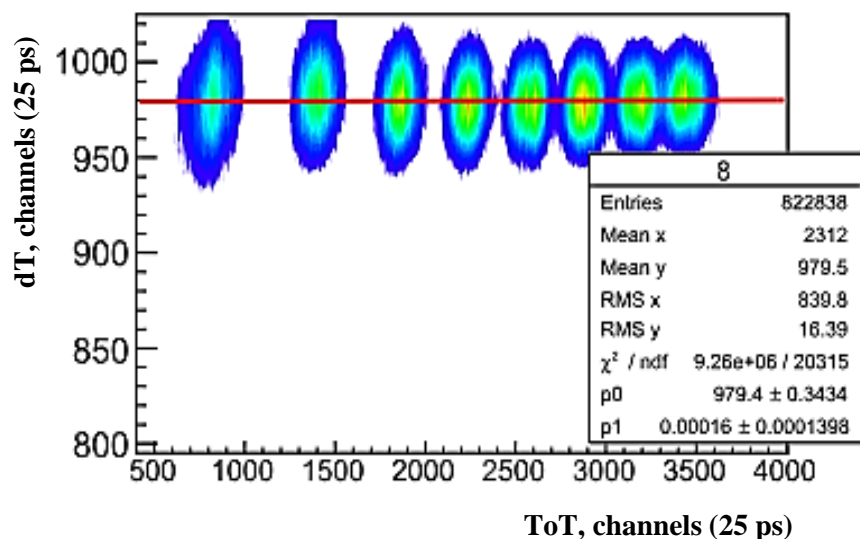

Corrected dT(SiPM1-SiPM2)

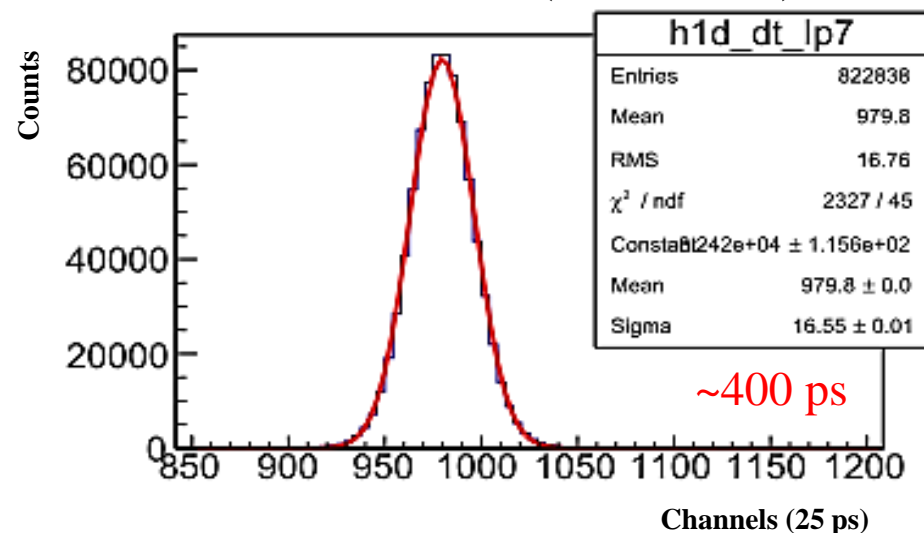

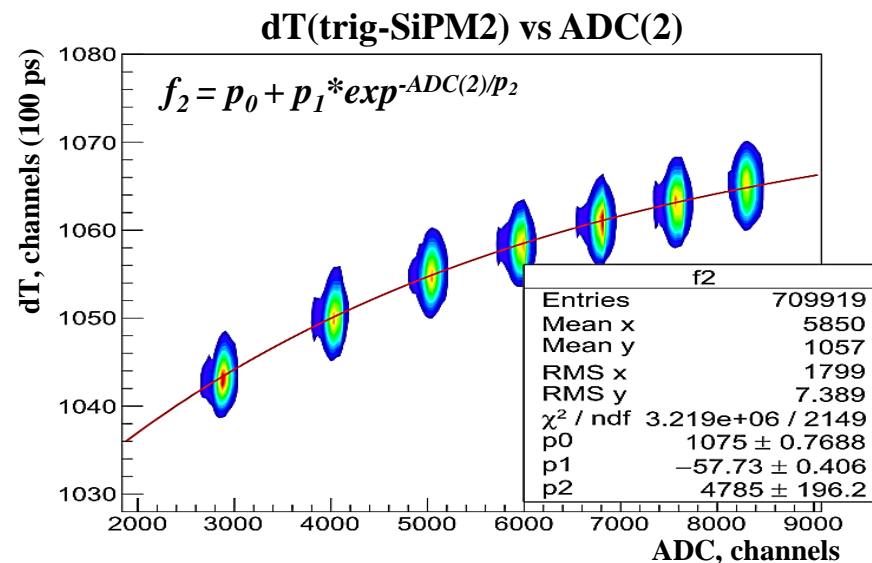
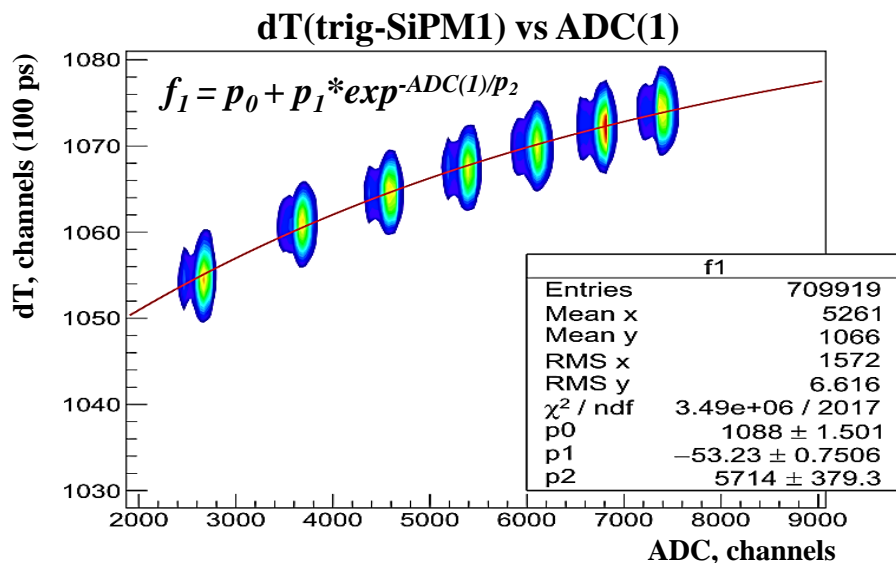
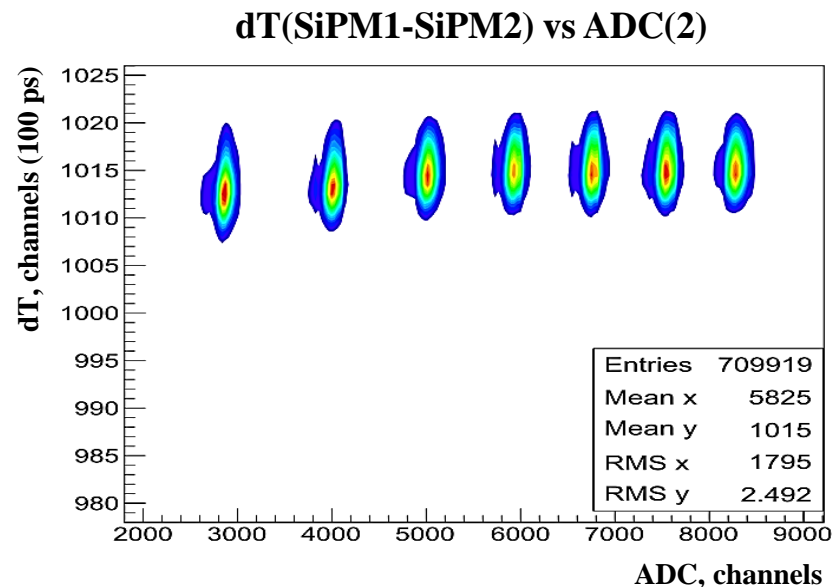
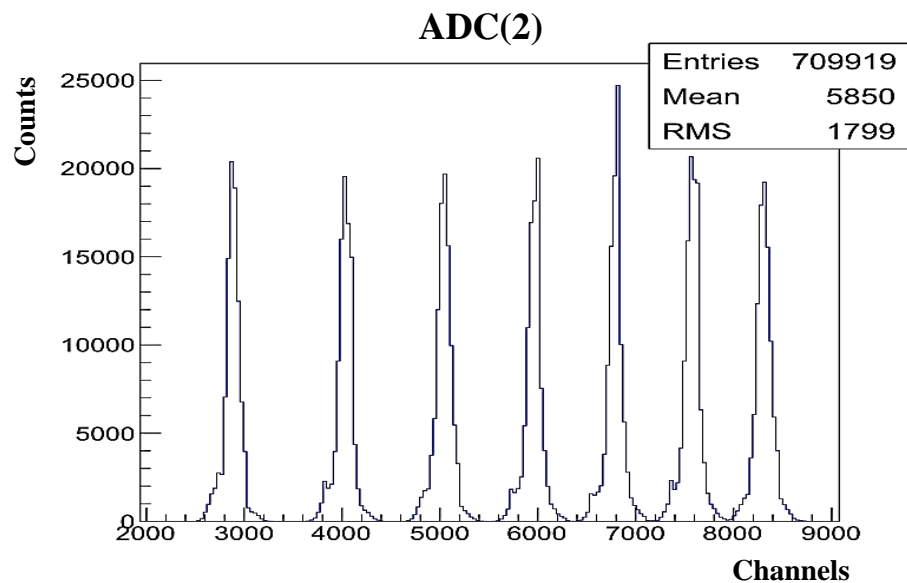

Introduction
 The prototype
 The equipment
Results

The time difference histogram
FEE DANSS

dT(SiPM1-SiPM2) vs ADC(2)

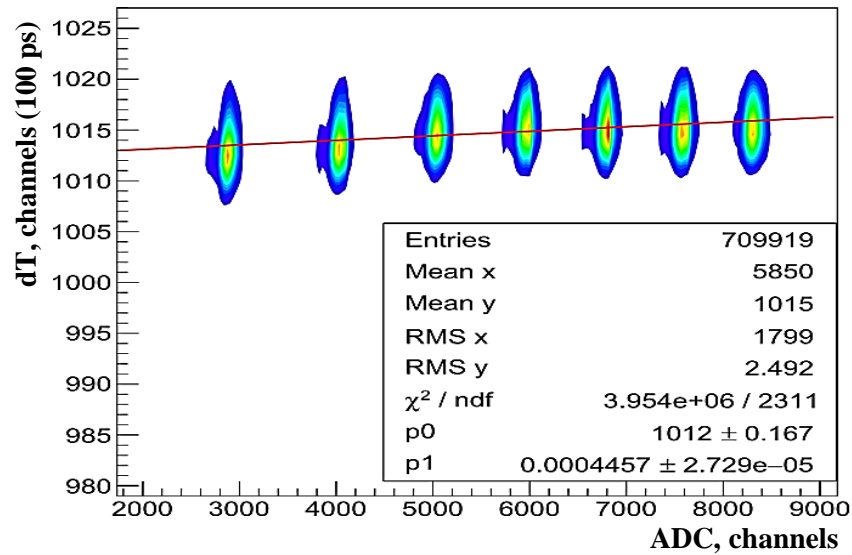

dT(SiPM1-SiPM2)

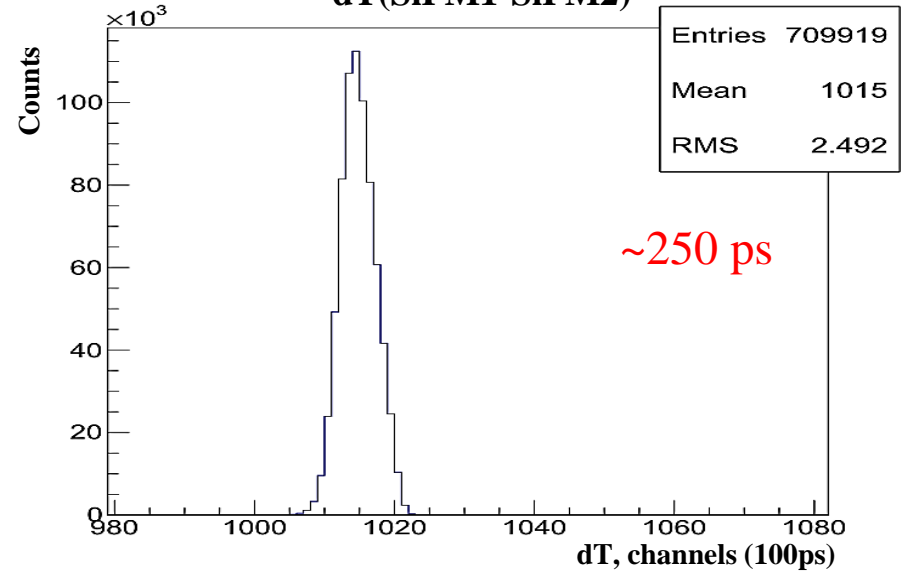

Corrected dT(SiPM1-SiPM2) vs ADC(2)

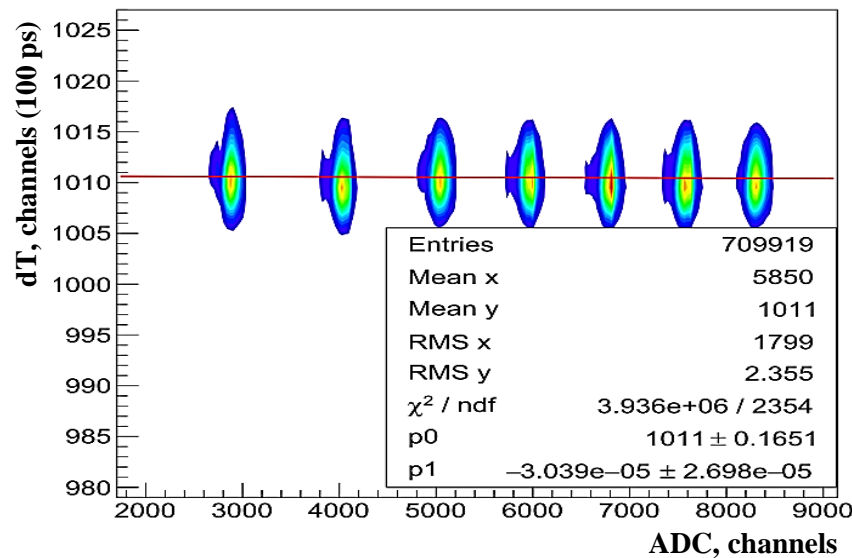

Corrected dT(SiPM1-SiPM2)

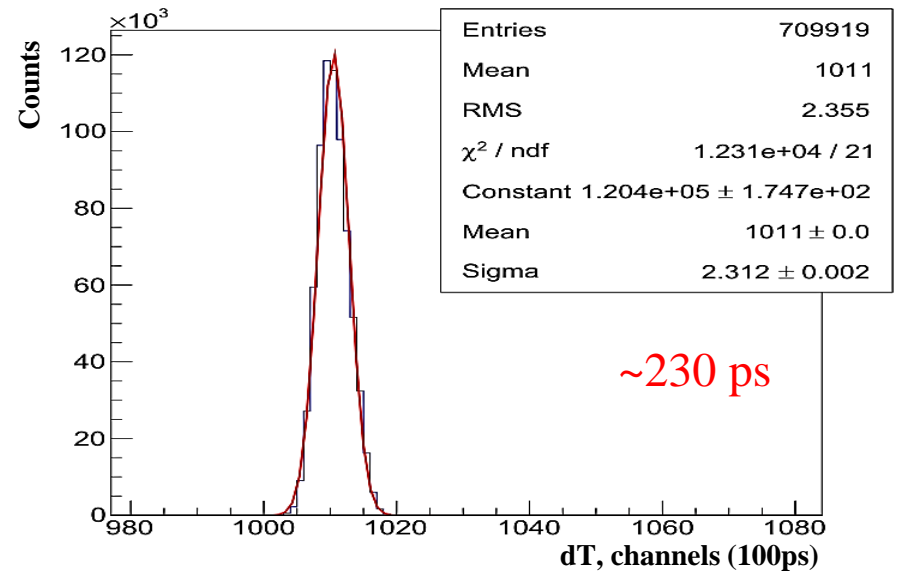

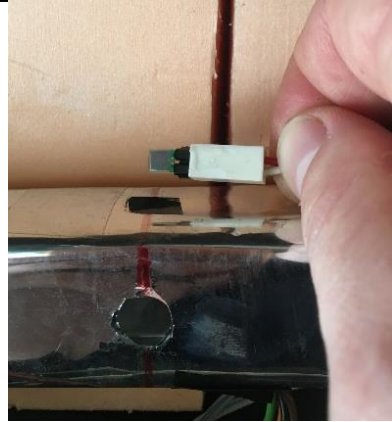

5 channels FEE DANSS

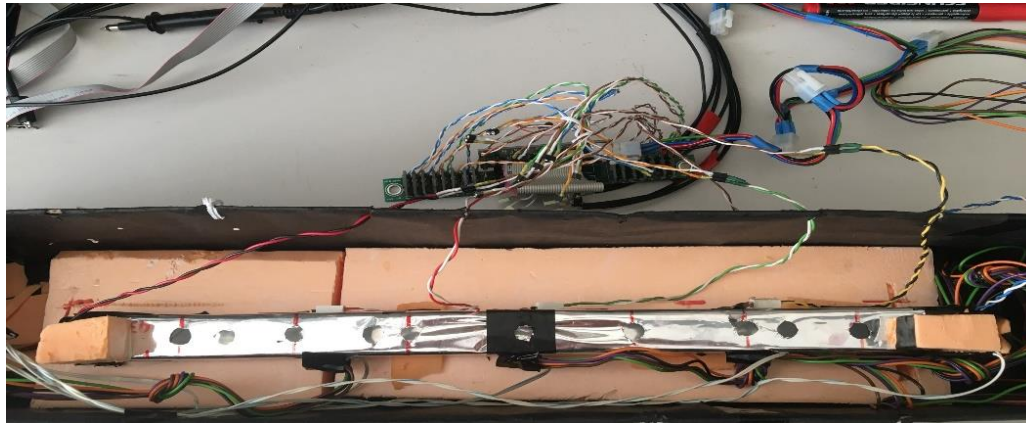

10 pcs HAMAMATSU
(S12572-010P)

Plastic Scintillator
40 x 2 x 2 (cm³)

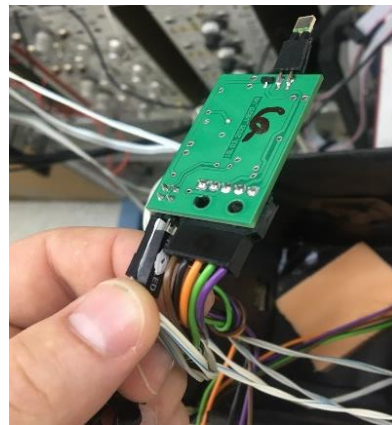

5 channels FEE ToT (version №2)

Introduction
 The prototype
 The equipment
Results

Extracting correction parameters
FEE ToT (version №2)

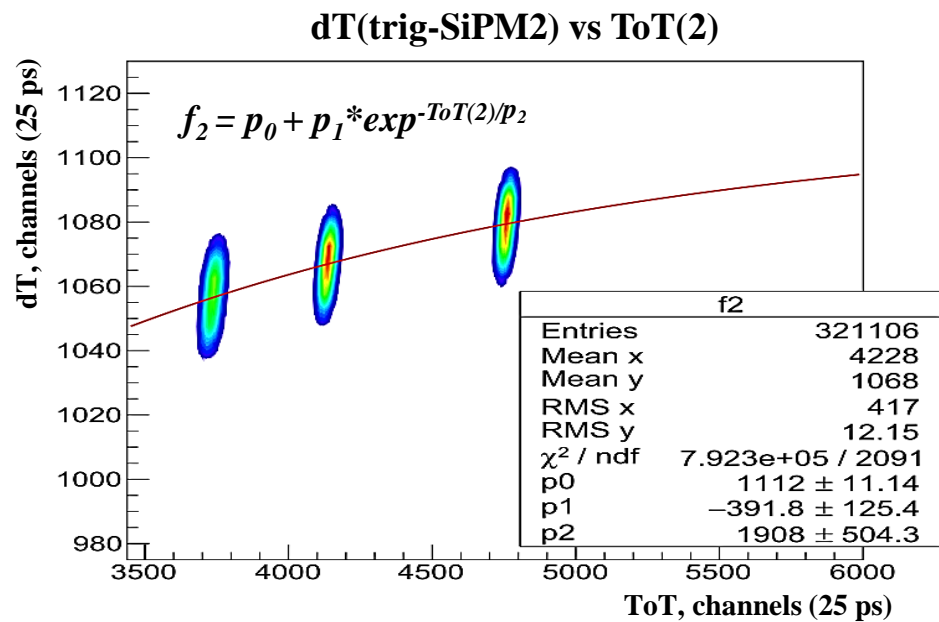
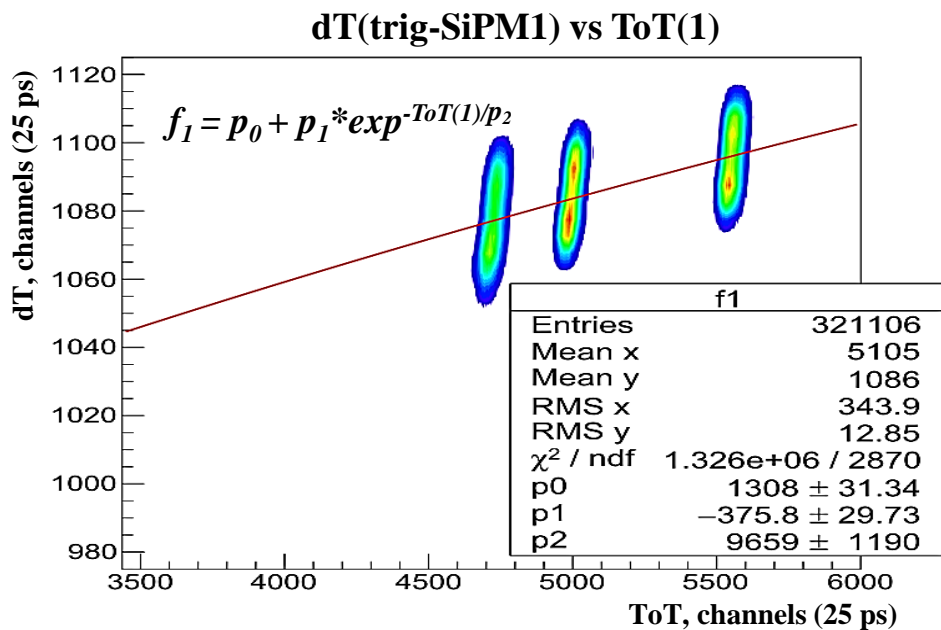
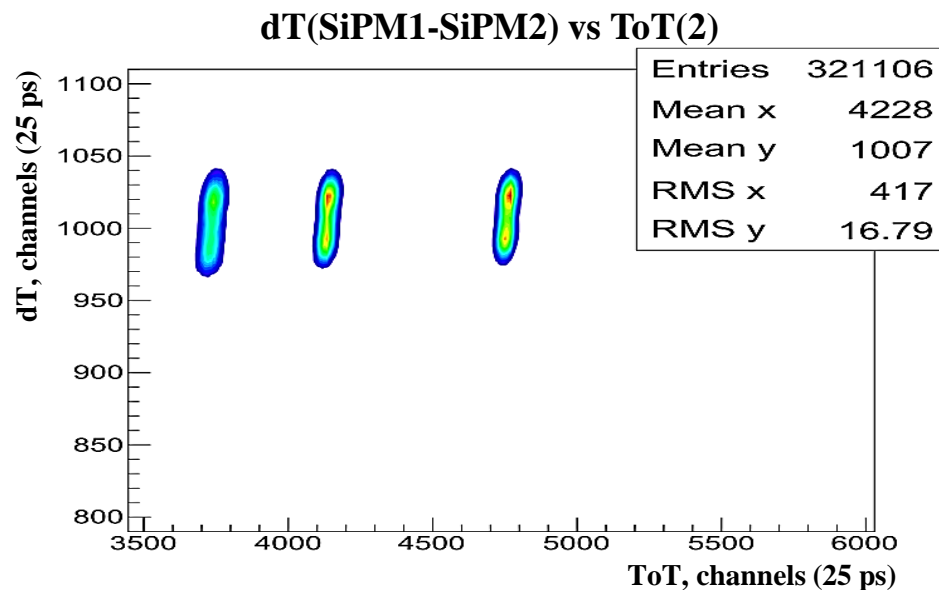
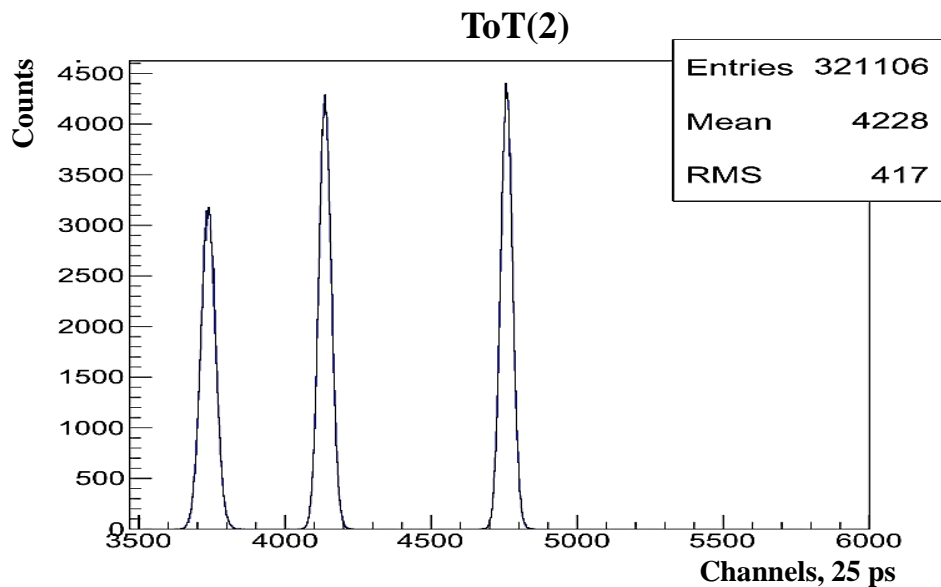

Introduction

The prototype

The equipment

Results

The time difference histogram FEE ToT (version №2)

dT(SiPM1-SiPM2) vs ToT(2)

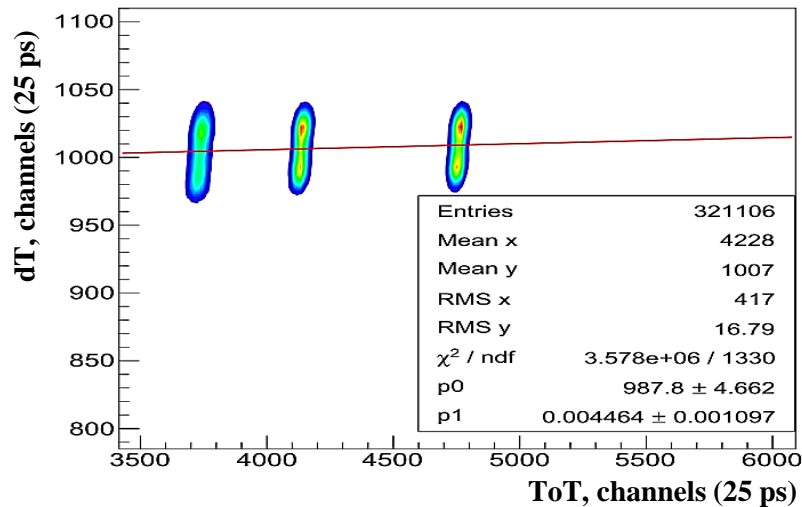

dT(SiPM1-SiPM2)

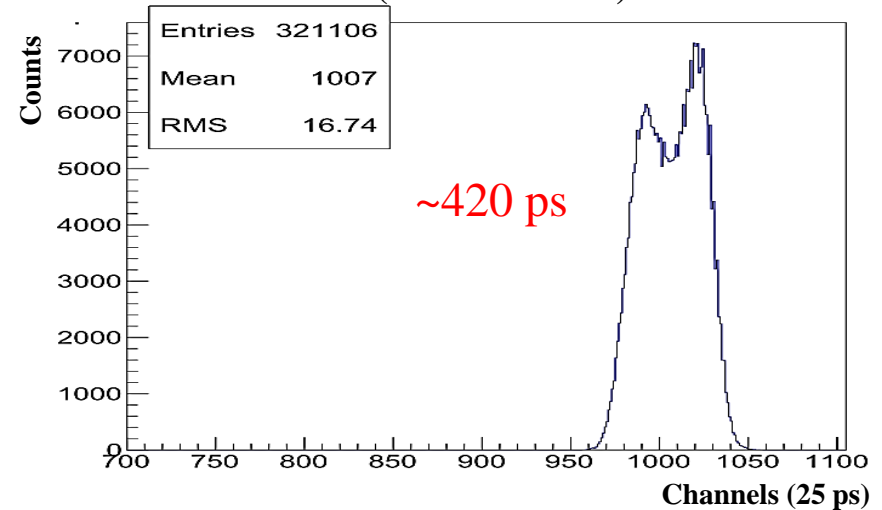

Corrected dT(SiPM1-SiPM2) vs ToT(2)

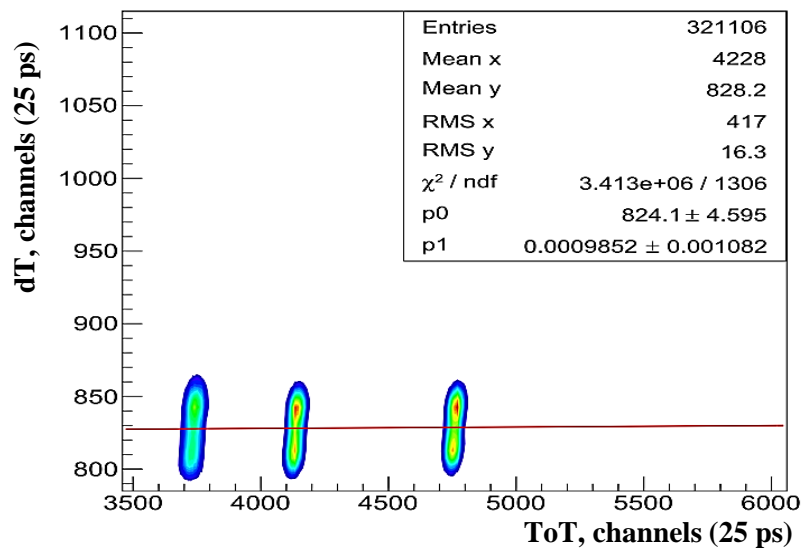

Corrected dT(SiPM1-SiPM2)

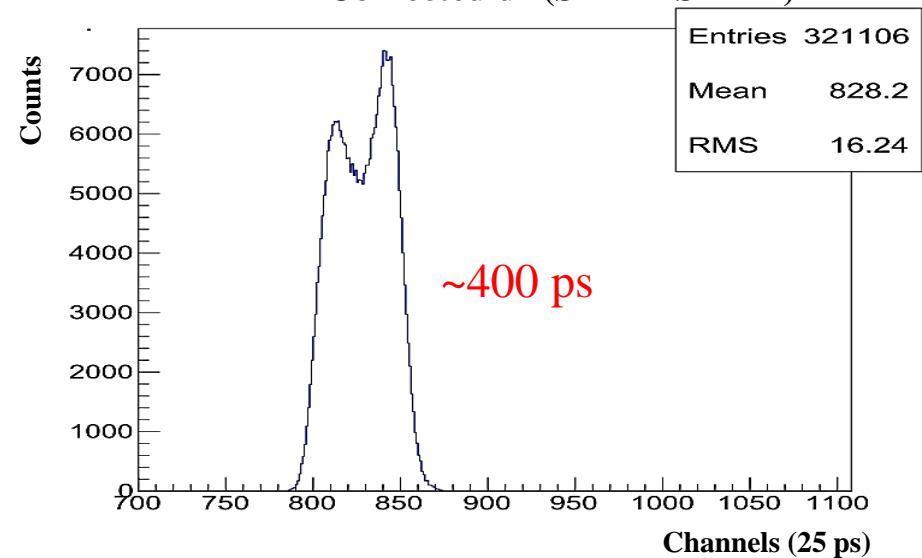

Introduction

The prototype

The equipment

Results

The time difference histogram FEE ToT (version №3)

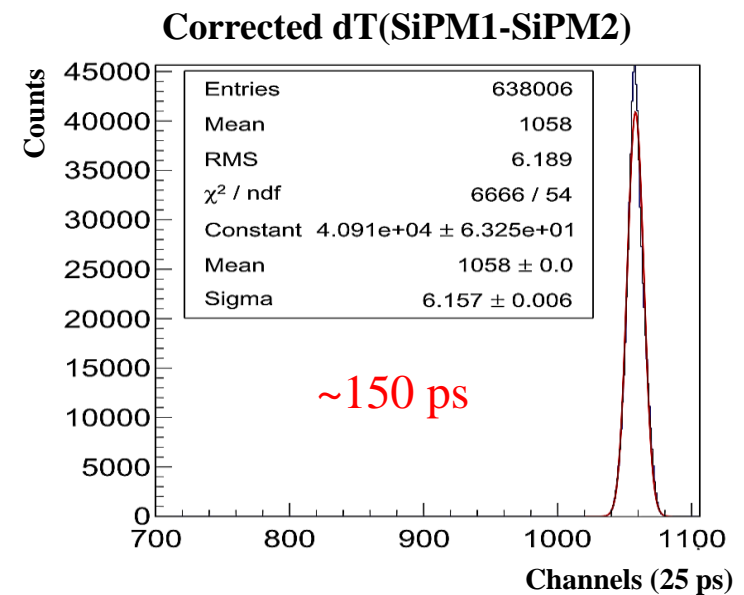
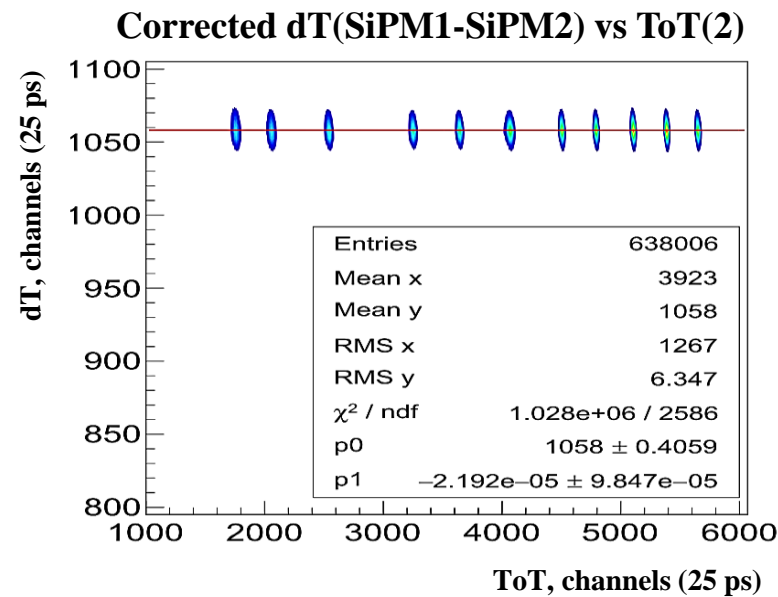
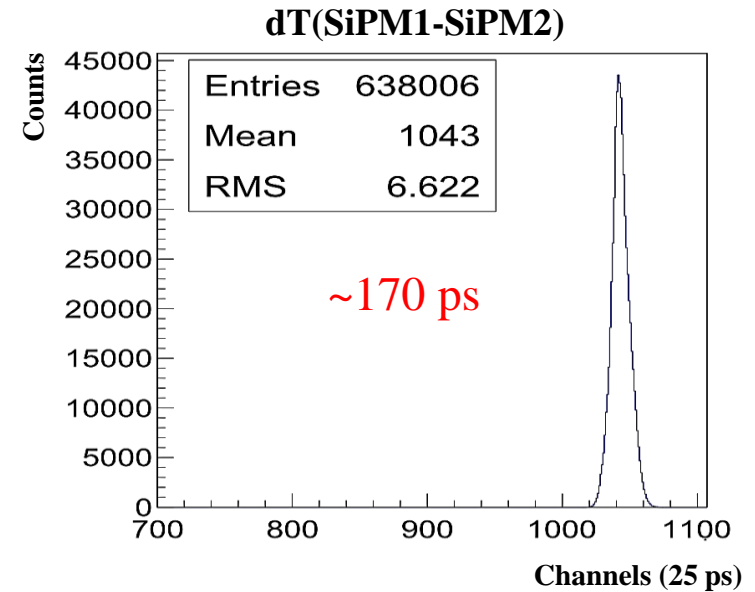
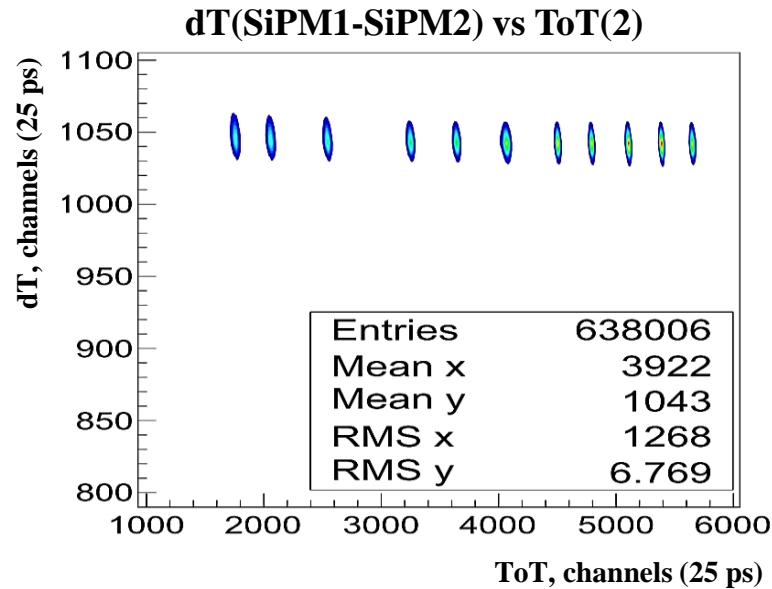

ToT

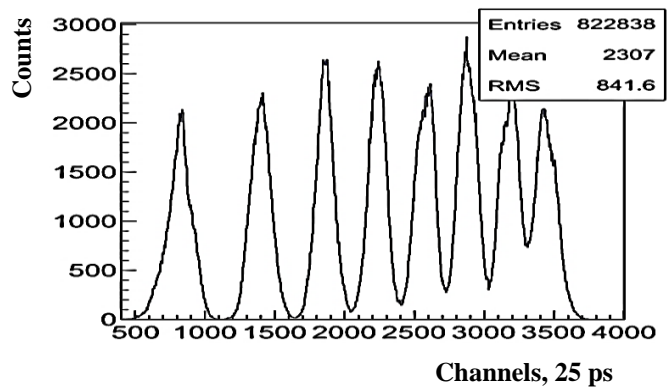

v.1

Corrected dT(SiPM1-SiPM2)

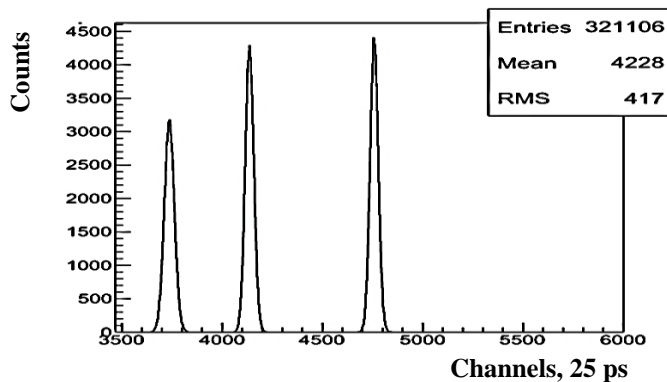
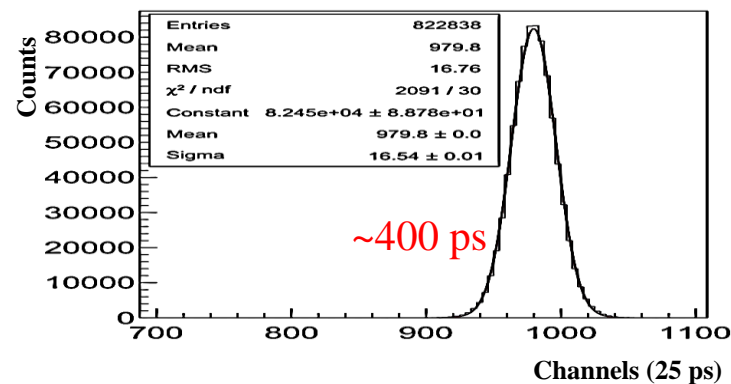

v.2

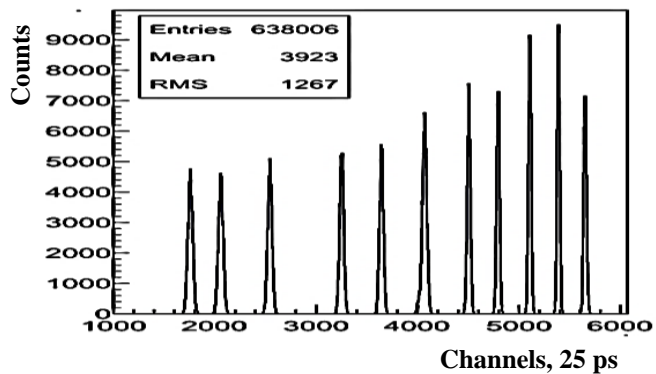
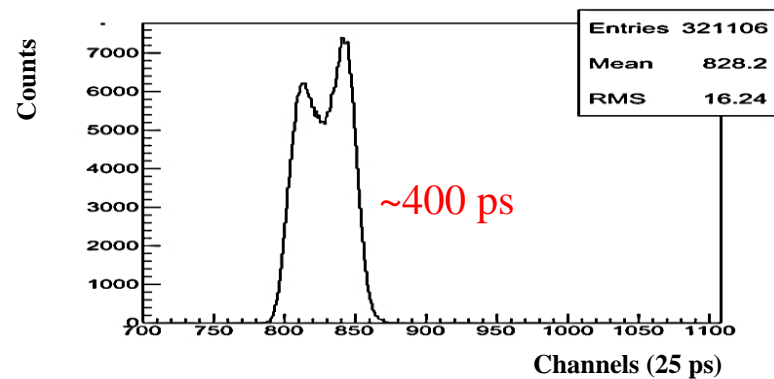

v.3

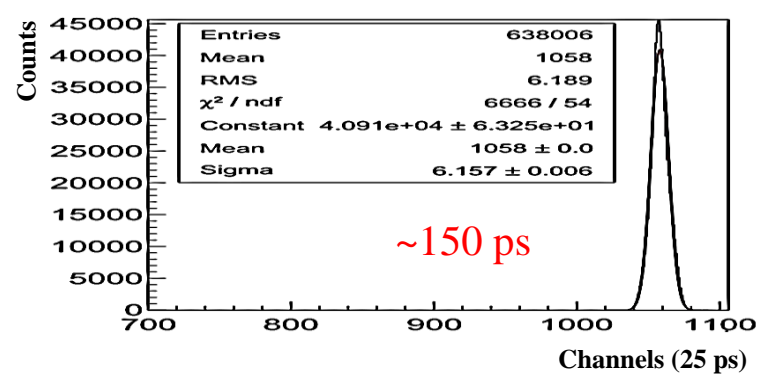

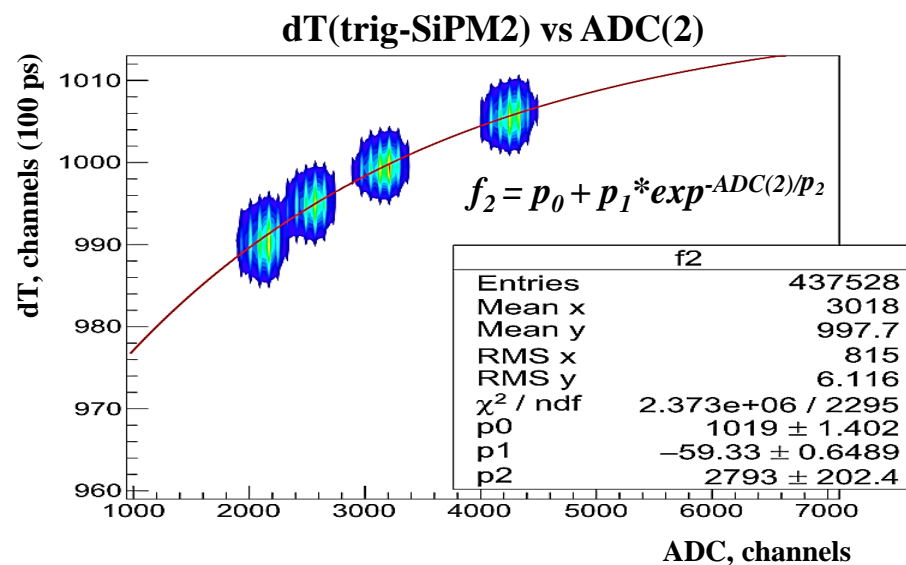
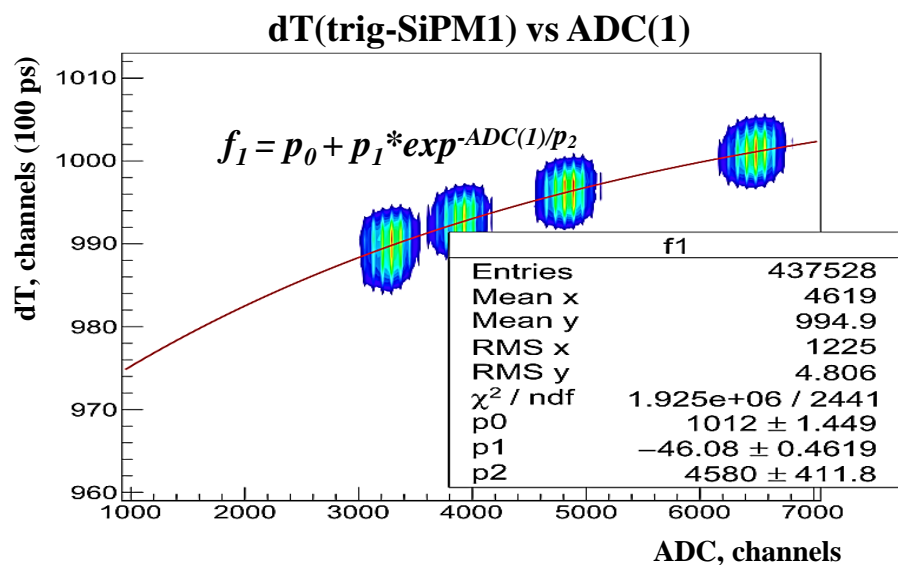
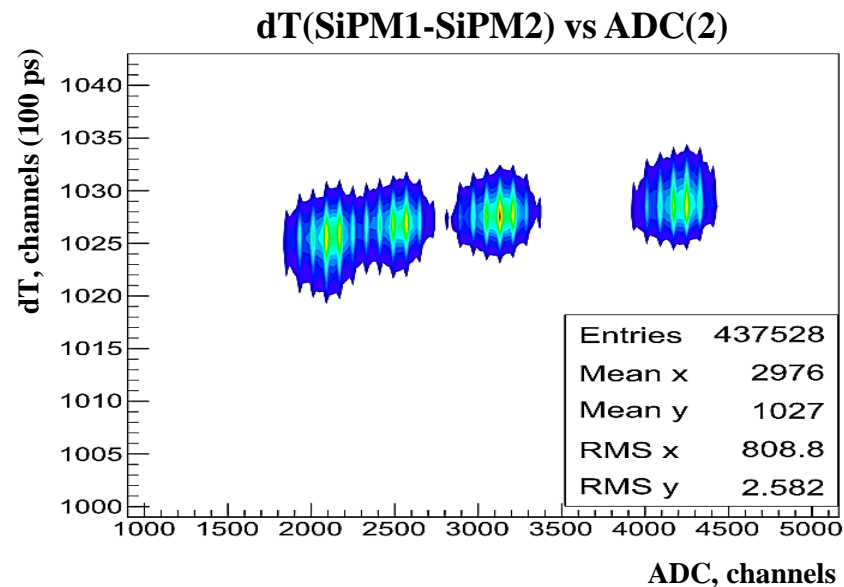
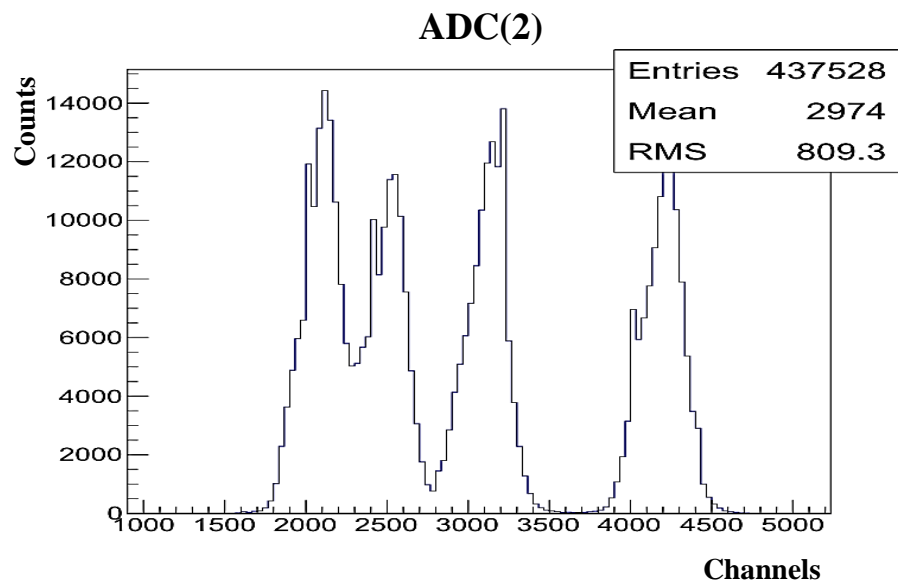

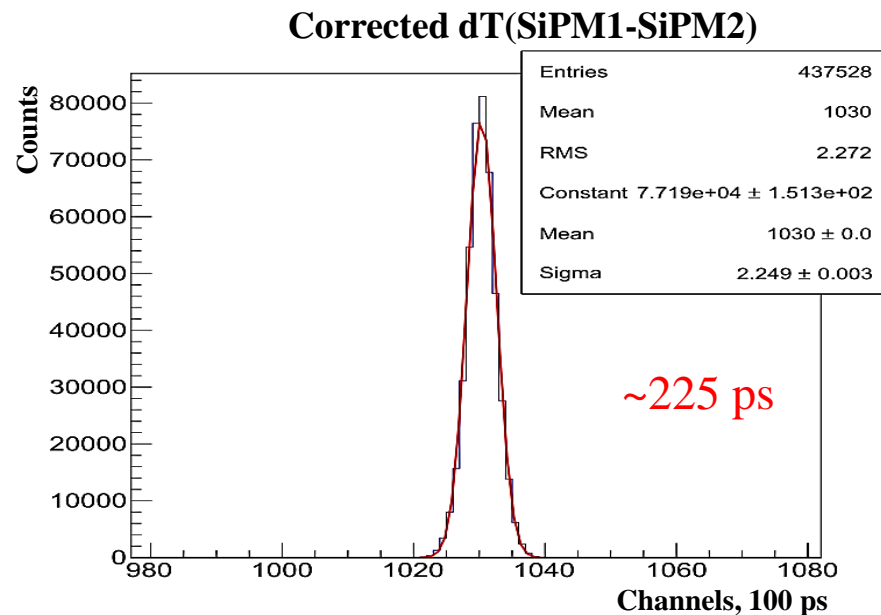
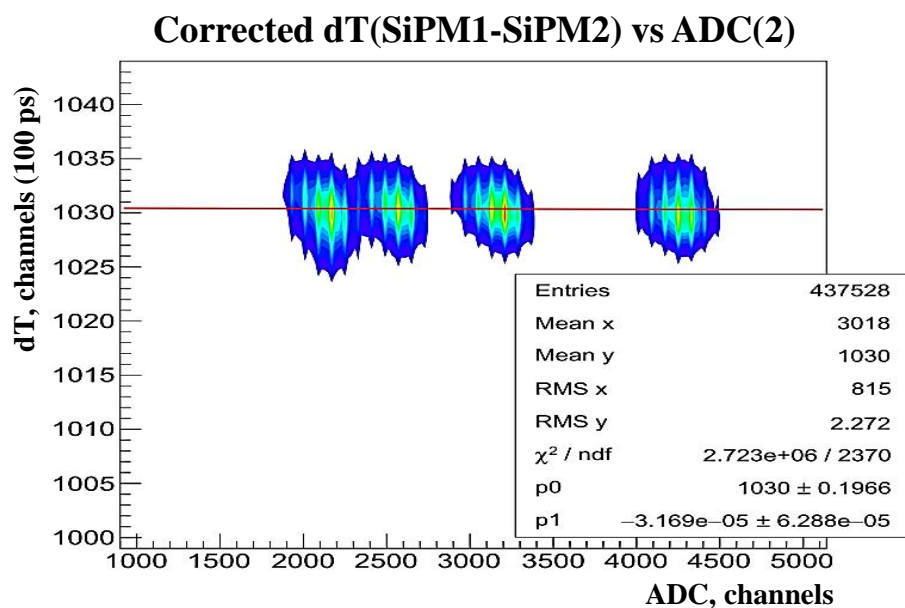
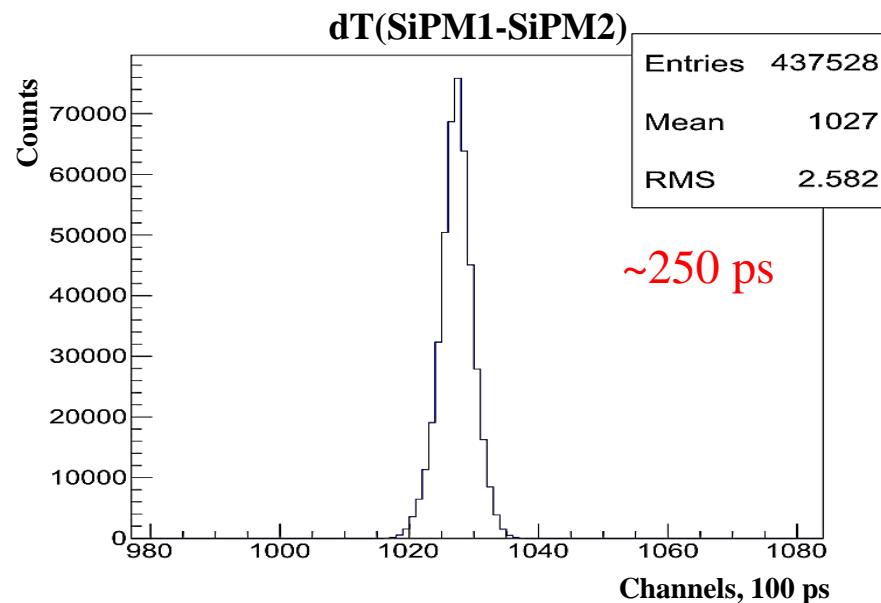
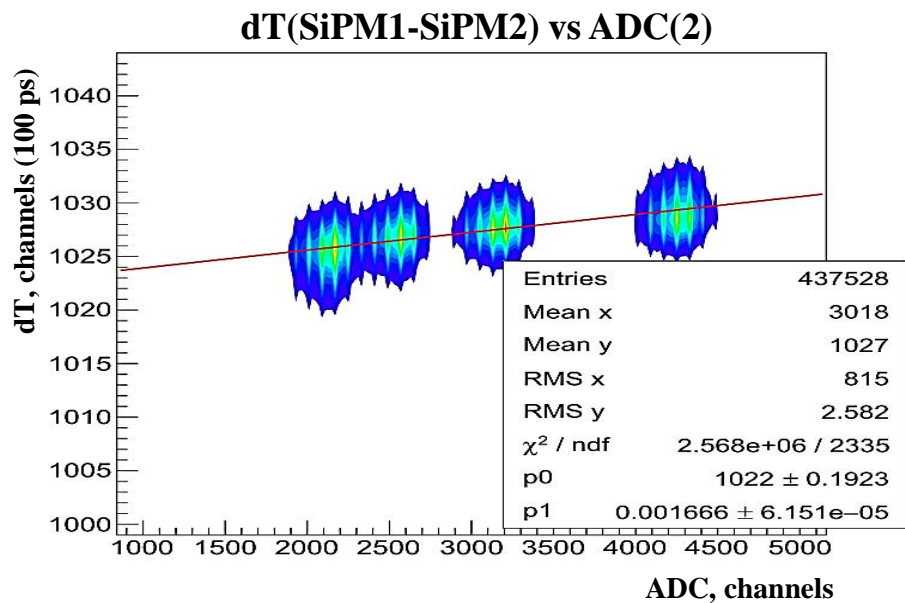

FEE ToT

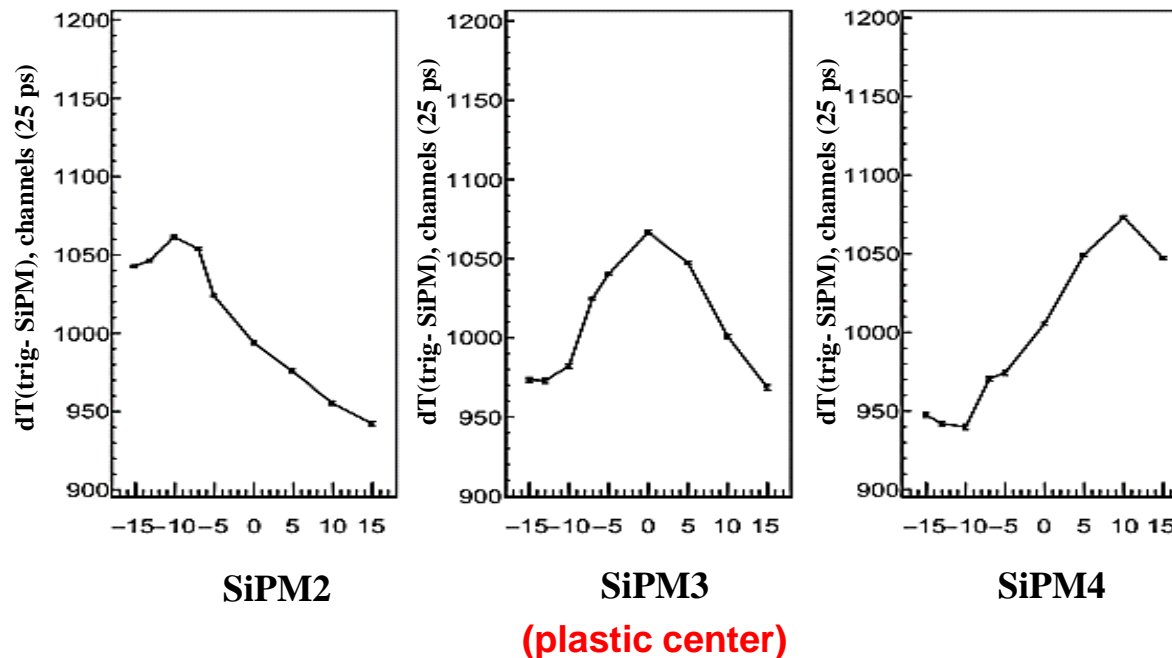

FEE DANSS

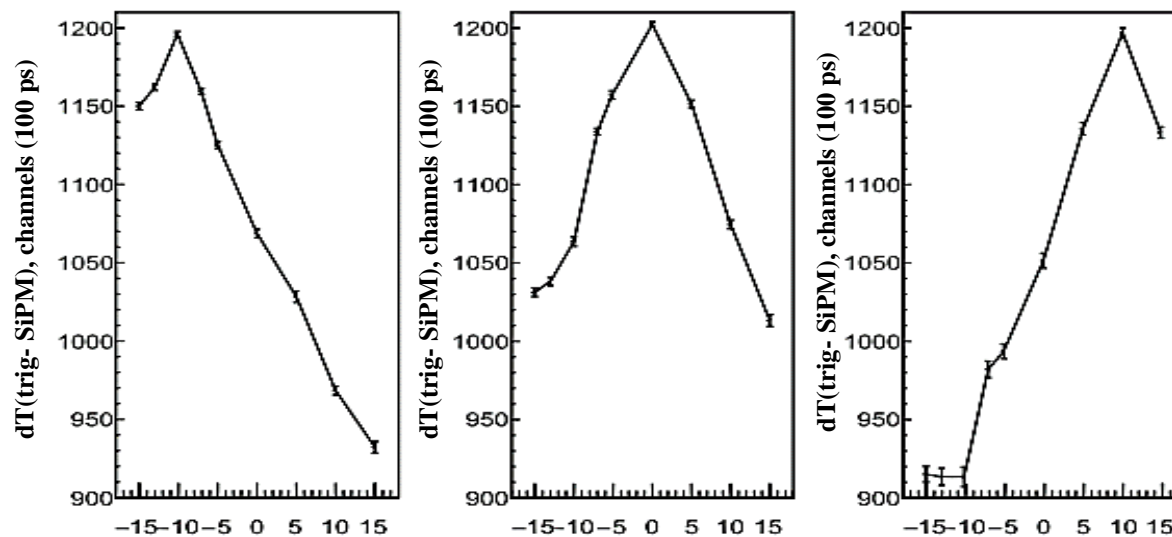

- Testing the 3rd version of the TOT electronics with new power sources.
- Analysis of the recorded data set and determine the coordinate resolution.
- Test another types of SiPM.
- Preparation of several prototypes with the sizes of scintillation tiles 10x10 (cm²) and 30x30 (cm²) for a run at the Nuclotron.

- I. The first version of the scintillation detector prototypes with two types of FEE for the future Spin Physics Detector at NICA with Hamamatsu (S12572-010P) SiPM readout have been developed.
- II. Two versions of Front-end electronics based on the Time-over-Threshold method have been tested. The test of the next version of electronics is required.
- III. The DANSS electronics (ITEP) has been tested and has shown an reasonable results.

Thank you for your attention!

Special thanks to my colleagues from the DSS group

Backup

16 channel



a size of
78x78 mm²

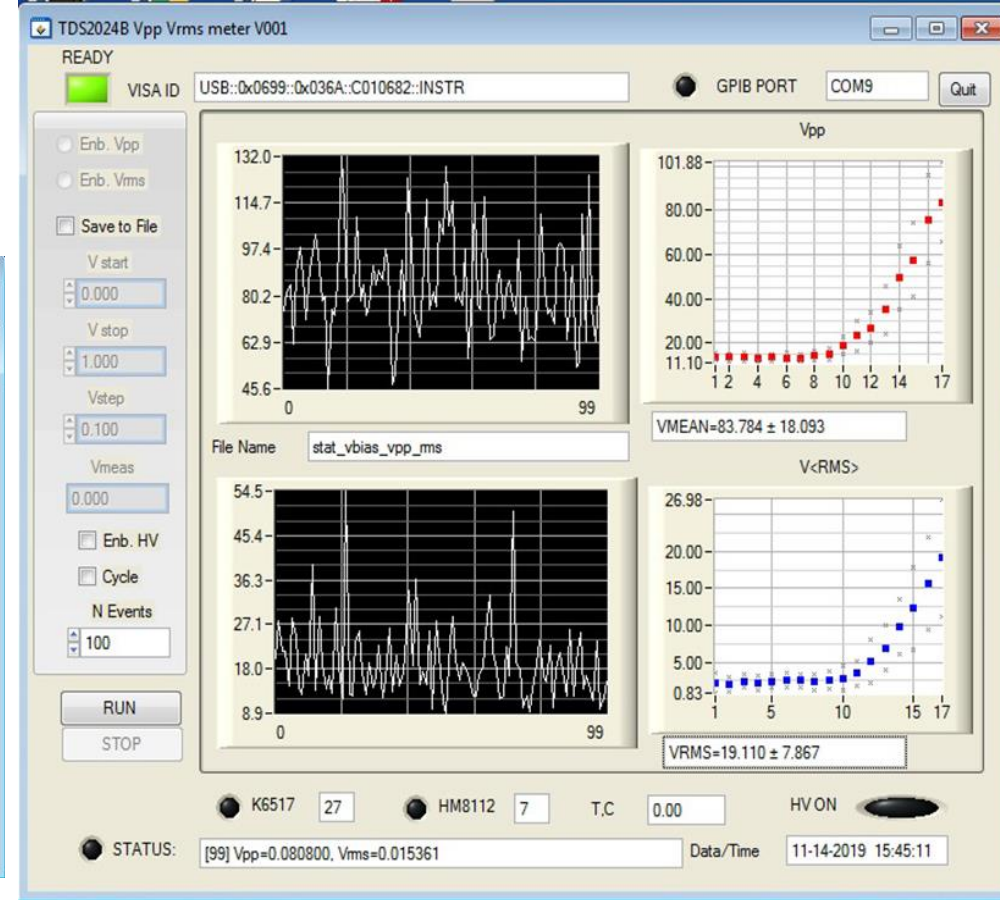

It's the 16-channel prototype of detector. This prototype is implemented on two PCBs. They contain power supply for sixteen SiPMs. The bias voltage is set by the HVsys program, which allows to set the total and the individual voltage.

Averaging peak-to-peak amplitudes was performed on 100 measurements with corresponding error to reduce the contribution of noise signal pulses and increase accuracy.

Tishevskiy A.V. et al. // to be published in Phys.Atom.Nucl., 2020, Vol. 83, No. 11

the energy 4 GeV / nucleon
 the intensity $1 \times 10^6 - 8.5 \times 10^8$

$$U_{\text{bias}} = 23,0 - 24,7 \text{ V}$$

The trigger was the coincidence of two scintillation counters from different sides of the Nuclotron ion pipe.

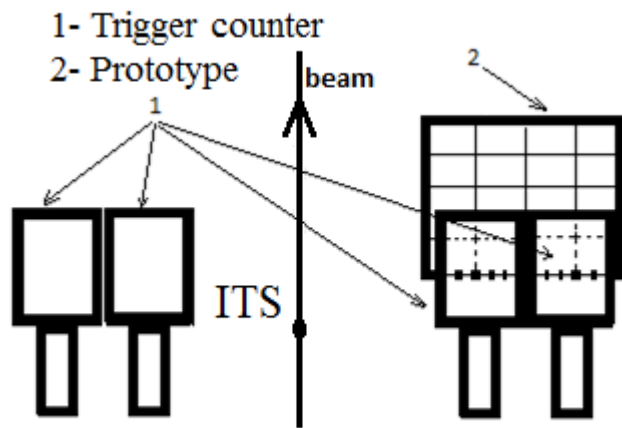
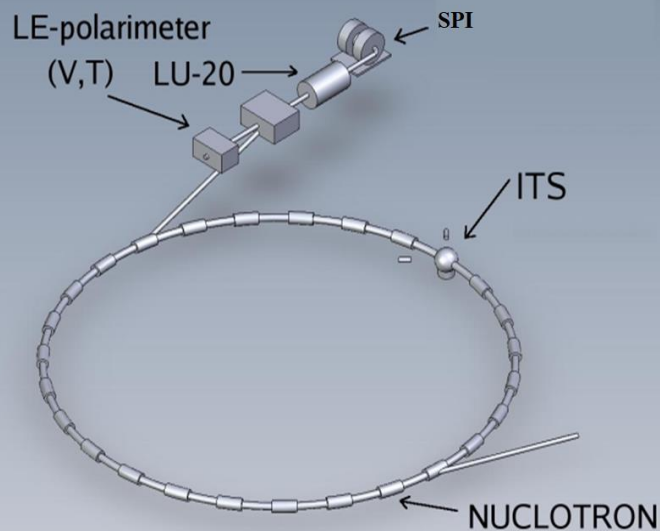

$$\begin{cases} \sigma_1^2 = \sigma_L^2 + \sigma_R^2 \\ \sigma_2^2 = \sigma_L^2 + \sigma_{Ch}^2 \\ \sigma_3^2 = \sigma_R^2 + \sigma_{Ch}^2 \end{cases} \quad (1)$$

$$\begin{aligned} \sigma_L^2 &\approx \sigma_R^2 = \sigma_0^2 \\ \sigma_1^2 &= 2\sigma_0^2 \end{aligned} \quad (2)$$

$$\begin{aligned} \sigma_{Ch} &= \sqrt{\sigma_2^2 - \sigma_0^2} \\ \sigma_{Ch} &= \sqrt{\sigma_3^2 - \sigma_0^2} \end{aligned} \quad (3)$$

Hamamatsu
 H741MOD photo-
 multiplier tube

The time difference histogram

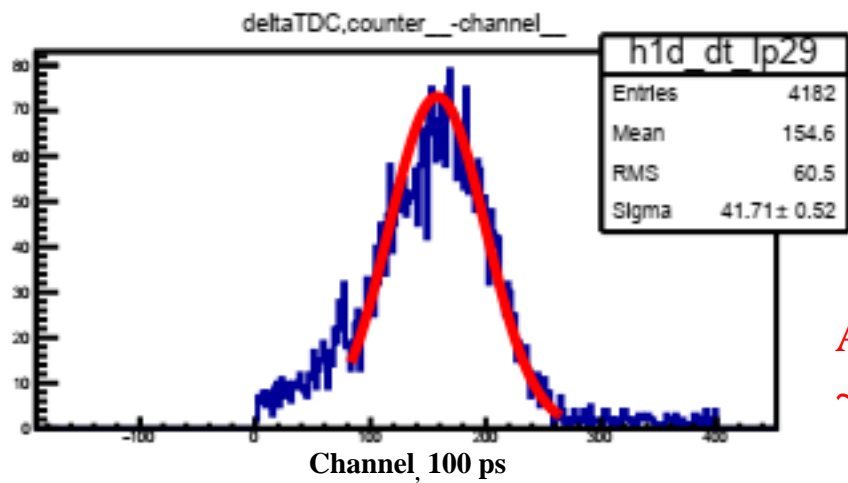
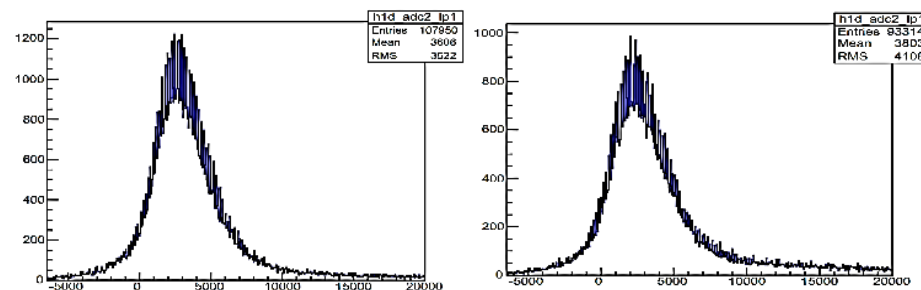
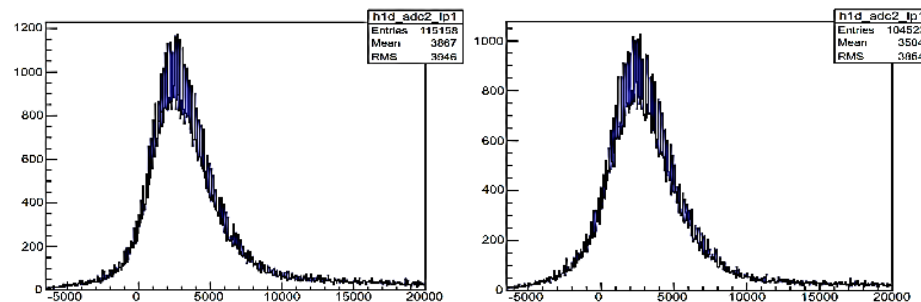
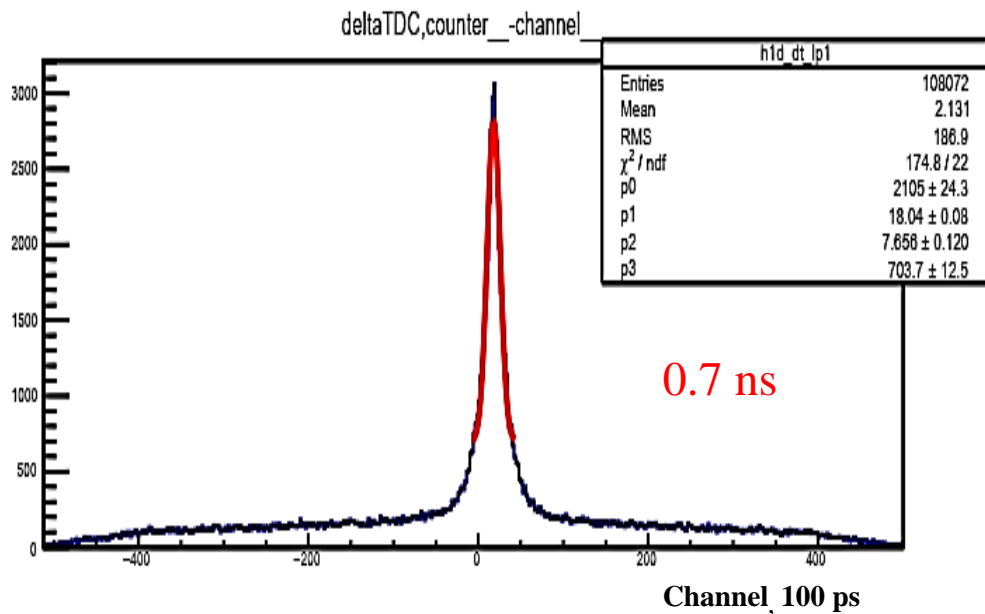

Average
 ~ 4.0 ns

