

# Muon System for Spin Physics Detector at NICA

---

**Georgy Golovanov**

*on behalf of the SPD Muon Group*

DLNP, JINR, Dubna

New Trends in High Energy Physics

September 24 – 30, 2018

Budva, Montenegro

# Table of contents

1. Introduction
2. SPD Muon Range System
3. SPD Range System R&D Program
4. Conclusion

# Introduction

---

# Polarized beams of NICA collider

Basic specification of polarization states and combinations available at NICA:

- protons: longitudinal and transverse polarization with respect to a particle velocity direction;
- deuterons: vertical direction of polarization at  $90^\circ$  up to 4 GeV/c momentum;
- possibility to collide any available polarized particles: proton - proton, proton - deuteron, deuteron - deuteron.

The polarization control system conditions:

- Longitudinal and transverse polarization degree  $\geq 70\%$ ;
- collision luminosity of  $\sim 10^{30} - 10^{32} \text{ cm}^{-2}\text{s}^{-1}$  over the particle momentum range from 2 to 13.5 GeV/c;
- particle energy scan with a step of 1.0 GeV (DY,  $J/\psi$ ).

# Physics motivation

The SPD project is under preparation at the 2<sup>nd</sup> interaction point of NICA collider. The main purpose of this experiment is the study of the nucleon spin structure with high intensity polarized proton and deuteron beams. Both beams are supposed to be effectively polarized.

One gives the unique possibilities to investigate a wide range of polarized phenomena:

- Drell Yan processes;
- Direct photons;
- $J/\psi$  production processes;
- Studies of elastic reactions;
- Spin effects in one and two hadron production processes;
- Spin effects in inclusive high- $p_T$  reactions;
- Final spin states effects and polarization effects in heavy ion collisions.

# Drell Yan pair production

From the measured azimuthal asymmetries in unpolarized and polarized DY processes a set of PDFs can be derived:

1. Transversity  $A_{UT}^{\sin(\phi+\phi_s)}$ ;
2. Sivers  $A_{UT}^{\sin(\phi-\phi_s)}$ ;
3. Pretzelosity  $A_{UT}^{\sin(3\phi-\phi_s)}$ ;
4. Boer-Mulders  $A_{UU}^{\cos(2\phi_h)}$ ;
5. Worm-Gears  $A_{UL}^{\cos(2\phi_h)}$ .

The above PDFs are proposed to be measured with SPD.

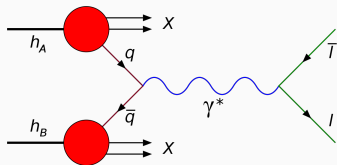

## Leading Twist TMDs



Nucleon Spin



Quark Spin

		Quark Polarization		
		Un-Polarized (U)	Longitudinally Polarized (L)	Transversely Polarized (T)
Nucleon Polarization	U	$f_1 = \odot$		$h_1^\perp = \uparrow - \downarrow$ Boer-Mulders
	L		$g_{1L} = \rightarrow - \leftarrow$ Helicity	$h_{1L}^\perp = \rightarrow - \leftarrow$
	T	$f_{1T}^\perp = \uparrow - \downarrow$ Sivers	$g_{1T}^\perp = \uparrow - \leftarrow$	$h_1 = \downarrow - \uparrow$ Transversity $h_{1T}^\perp = \rightarrow - \uparrow$

# Direct Photon production

Direct (prompt) photons are the ones produced by hard scattering of partons.

1. Quark (antiquark) gluon Compton scattering dominates in wide kinematical region (up to hundreds GeV);
2.  $q\bar{q}$  annihilation process.

Direct photons production is an appropriate way to access the gluon structure of hadrons with SPD (e.g. gluon Sivers function  $A_N^\gamma$ ).

$$d\sigma^{dir} = \sum_{a,b=q,\bar{q},g} \int dx_a dx_b f_a^A(x_a, Q^2) f_b^B(x_b, \mu^2) d\sigma(x_a, x_b, Q^2)$$

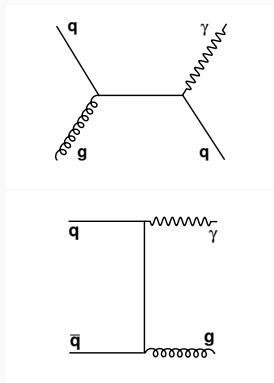

## Requirements to SPD design

The proposed detector design should meet with set of requirements developed on proposed physics program mentioned above:

- Close to  $4\pi$  geometrical acceptance;
- High-precision ( $\sim 50 \mu\text{m}$ ) and fast inner tracker;
- High-precision ( $\sim 100 \mu\text{m}$ ) and fast tracking system,
- Good particle ID capabilities;
- Efficient muon range system,
- Good electromagnetic calorimeter,
- Trigger and DAQ system able to cope with event rates at luminosity of  $10^{32} \text{ cm}^2\text{s}^{-1}$ ,
- Modularity and easy access to the detector elements, that makes possible further reconfiguration and upgrade of the facility.



# SPD concept

Main parameters of possible SPD design:

1. length along the beam axis: 9.2 m;
2. diameter: 6.8 m;
3. consists of 3 parts: a barrel and 2 endcaps;
4. each part has individual magnet system, the endcaps – Helmholtz coils, central part – toroidal one;
5. estimated total weight of SPD is about 2000 ton.

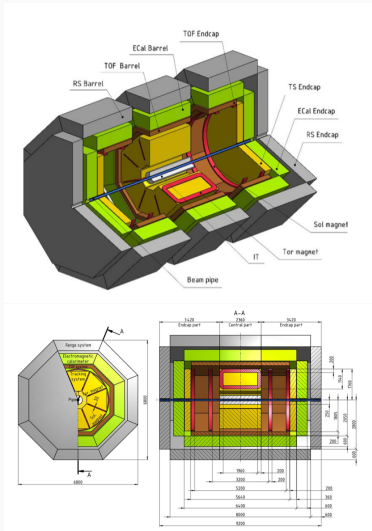

Subsystems: Electromagnetic Calorimeter, Time-Of-Flight, Trigger elements, Tracking system, Inner tracker and Muon Range System (as of 7/09/2018).

# SPD Muon Range System

---

# Mini-Drift Tubes

A Mini-Drift Tubes (MDT) tracking detector consists of an array of cells with anode wire in the center

(Aluminum larocci tubes).

- cell size  $\sim 1$  cm;
- total number of cells  $\sim 10^4 - 10^6$ ;
- $CO_2$  or  $CF_4$  gas;
- individual chambers with various number of cells up to 10 m long can be assembled to have  $\sim 10^2 - 10^3$  cells in a plane.

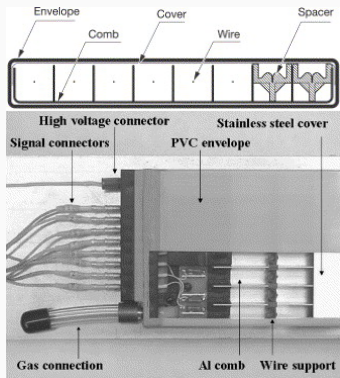

# Mini-Drift Tubes

## Advantages

- the detector is made of simple repetitive cells with properties defined by individual cell
- broken wires are localized inside a cell
- cell walls create self-supporting detector element

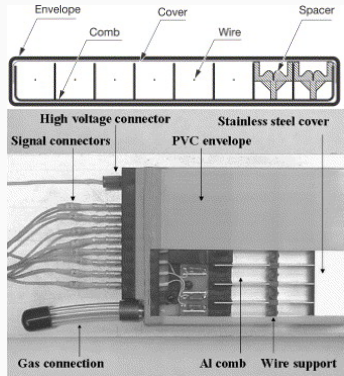

# SPD Muon Range System concept

- SPD/NICA Muon System is based on a range system technique
  - good Particle ID system for muon/hadron separation.
- works in full SPD energy range of secondary particles (at  $\sqrt{s}_{pp} = 12 - 27$  GeV).
- resolves muons and hadrons with  $\sim 100\%$  efficiency (zero hadron contamination) above  $\sim 1$  GeV by obviously different response pattern.
- **Main purpose:** separation of muons vs. pions (below 1 GeV is less efficient and requires test beam measurements for calibration)
- **Important feature:** the range system may be used as a coarse sampling hadron calorimeter (30 mm to 60 mm of Fe in our case)  
**very important for neutron registration!**

# SPD Muon Range System concept

- The Muon Range System structure is a well known solution for detecting the muons stopped by the absorber and those crossing the iron
- In first case, one may even roughly estimate the energy of muon. The stopping power of iron is about 1.5 GeV per meter of absorber for the relativistic muons with  $dE/dx = 2 \text{ MeV/g}$ .
- The barrel part iron absorber sampling is 3 cm, in the EC 6 cm sampling is selected for better detection of muons with higher energies.

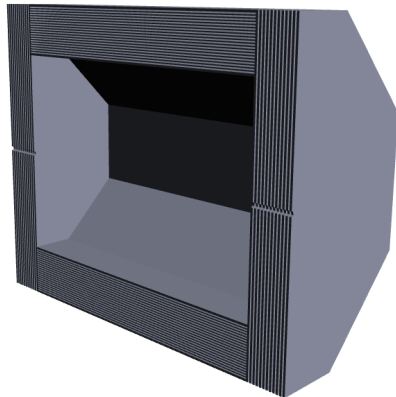

3D model of the SPD Muon Range System concept.

# SPD Muon Range System concept

3D model of the SPD Muon Range System concept  
Vertical cross section

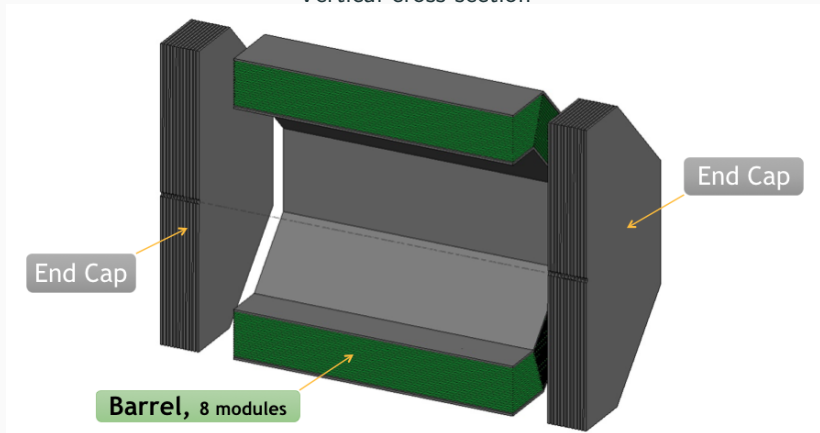

# SPD Muon Range System concept

- Barrel/Fe:  $60+19 \times 30+60$  mm ( $4 \lambda_i$ );
- End Caps/Fe :  $12 \times 60$  mm ( $4.2 \lambda_i$ );
- Air gaps = 35 mm; L/barrel = 8000 mm;
- $W = 997.3 + 2 \times 326.6 = 1650.5$  ton.

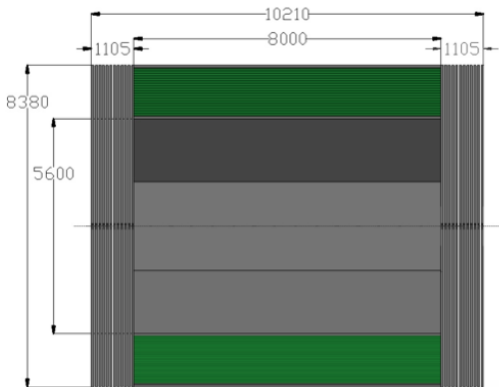



# SPD Muon Range System concept

## Barrel Structure (cross section)

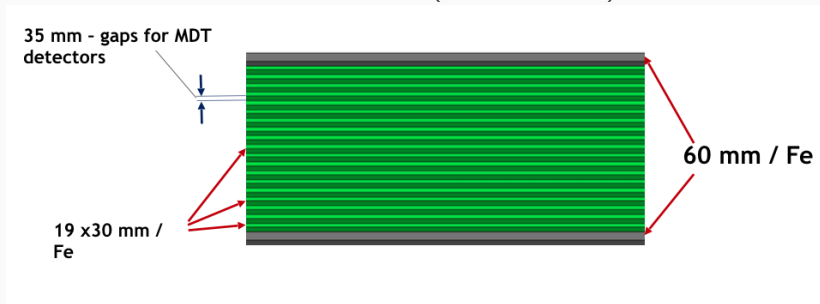

$$2 \times 60 \text{ mm} + 19 \text{ layers} \times 30 \text{ mm} \rightarrow 4 \lambda_i$$

# SPD Muon Range System concept

## End Cap Structure (cross section)

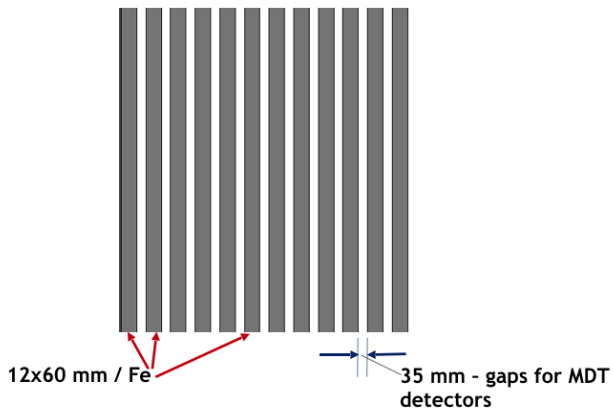

12 layers  $\times$  60 mm  $\rightarrow$   $4.2 \lambda_i$

# **SPD Range System R&D Program**

---

# Range System Prototype

## Range System Prototype (Project RE-22)

- 10 ton weight
- absorber plates (30 and 60 mm thick)
- 22 detecting layers (MDTs)
- wire and strip readout
- zero “bi-layers”

## SPD Muon Range System R&D program:

- Perform calibration of the system response to various particles at different energies
- Muon/hadron separation algorithm testing
- Digitization tuning

A2DB-32 cards for wire R/O  
(2160 channels)



ADB-32 cards for strip R/O  
(380 channels)

# Range System Prototype

## Range System Prototype

- It is designed as '2 in 1' device: the structure of absorber plates (30 and 60 mm thick) reproduces the different subsystems of the Muon System - Barrel or End Cap – depending on the particular direction of the test beam and number of engaged layers.
- MDT detectors 288 units  $\sim 1$  m long
- Strip boards 22 units with  $\sim 1$  m  $\times$  1 m size
- Corresponding front-end electronics (2160 channels for wire readout and 380 for strip readout).

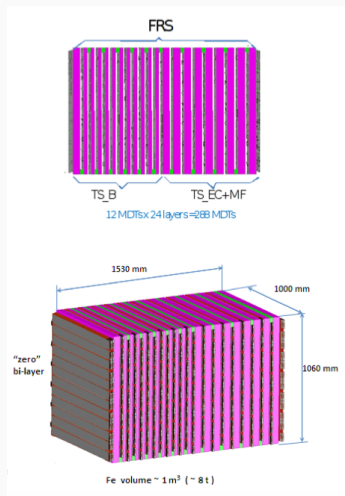

# Range System Prototype

The T9 secondary monochromatic beam of particles with momenta up to 15 GeV/c is generated at the PS accelerator (CERN).

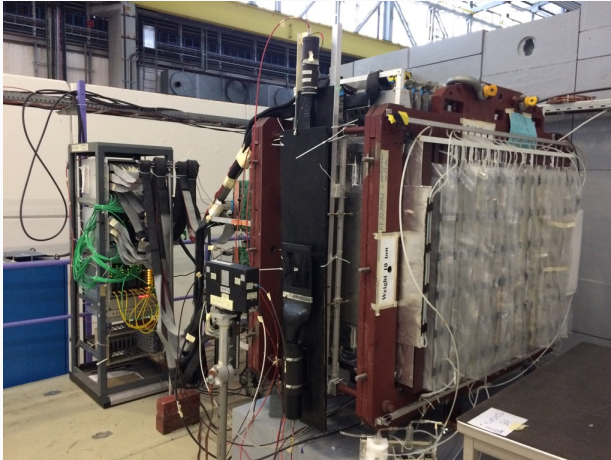

RSP with DAQ rack installed on the T9/PS test beam @ CERN

## Prototype data: $\pi/\mu$ separation

A study of the Range System Prototype response to a variety of passing particles with different momenta. The prototype is also equipped with TOF for particle-id and Cherenkov counters for vetoing electrons.

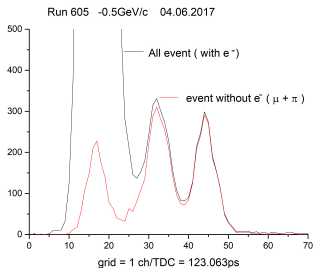

Time-of-flight distribution of the particles for the beam with momentum 0.5 GeV/c (zoom)

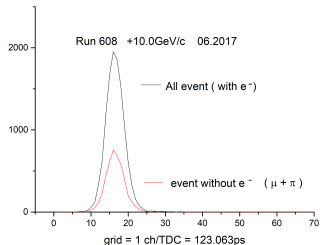

Time-of-flight distribution of the particles for the beam with momentum 10.0 GeV/c

With the increasing beam energy a possibility of particles separation by TOF detector is significantly reduced.

# Prototype data: $\pi/\mu$ separation

A hit profile in RSP corresponding to a particular kind of particles with a certain momentum has a specific pattern.

Low momentum pions ( $p < 1.0$  GeV/c) almost indistinguishable from muons with the same momentum.

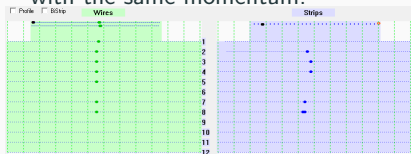

$\mu^- : 0.5$  GeV/c

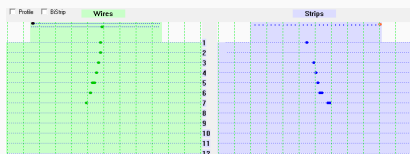

$\pi^- : 0.5$  GeV/c

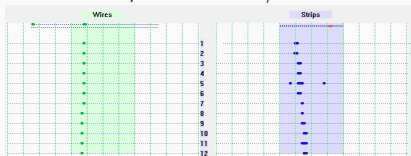

$\mu^- : 10.0$  GeV/c

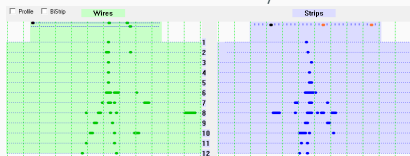

$\pi^- : 10.0$  GeV/c

The increasing energy of pions significantly changes the profile of hits, forming a hadron shower of secondary particles for pions with momentum up to 10.0 GeV/c.



## Prototype data: $\pi/\mu$ separation

Finding variables sensitive to differences in such patterns, is directly connected to the possibility of separation between muons and pions, e.g. the depth of the full energy deposition of the particles in the layered structure of the Range System (can be used as an input to various ML techniques).

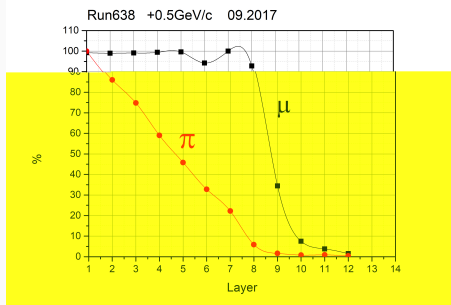

Only (20 – 25) % of pions reach the 7<sup>th</sup> plane, while almost all of the muons have the energy exceeding the threshold. The presence of hits above the 8<sup>th</sup> layer with a high degree of probability suggests that the particle is a muon, since no more than (1 – 2) % of pions reach the 9<sup>th</sup> plane.

# Prototype data: proton/antiproton calorimetry

Proton/antiproton calorimetry is implemented by measuring total number of hits in an event.

Various combination of layers can be used to simulate different parts of Muon Range System.

Proton calorimetry using sampling equivalent to End Cap part.

Proton calorimetry using sampling equivalent to Barrel part.

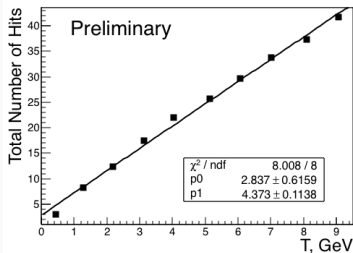

Sampling: 60mm (Fe). Nuclear interaction length  $\lambda_i \approx 5.2$

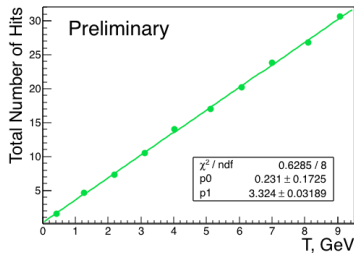

Sampling: 30mm (Fe). Nuclear interaction length  $\lambda_i \approx 2.3$

Range System Prototype allows to make proton energy calibrations by variation of detector thickness with chosen sampling. Analogous distributions will be made once the SPD Muon Range System design is well-established.

# Prototype data: proton/antiproton calorimetry

Antiproton calorimetry can be done using the same technique.

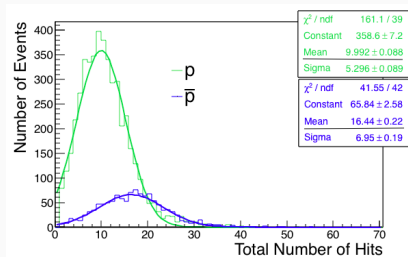

Comparison of the total number of hits for protons and antiprotons.

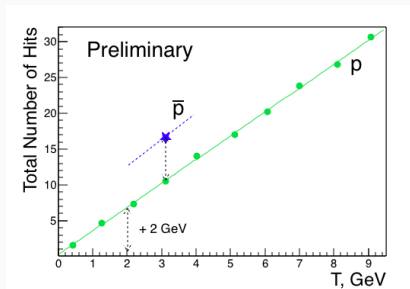

Sampling: 30mm (Fe). Nuclear interaction length  $\lambda_i \approx 2.3$

Two additional measurements were recently made for antiprotons which will allow to estimate the calibration line. Work in progress.

# Prototype data: neutron identification

Another important feature of the Range System is a possibility to identify neutrons.

- Use of the same charged particles monochromatic beam @ T9/PS;
- Carbon target as a neutron source;
- Scintillators for vetoing protons.

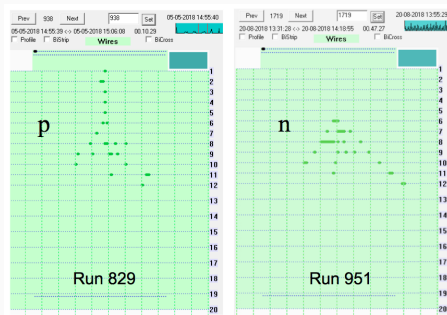

A sample of hit profile in the Range System Prototype for a neutron (right) compared to a proton (left).

A laminated iron/detector structure of the Range System may also serve as a coarse hadron calorimeter.

## Conclusion

---

# Summary

- The SPD project is under preparation at the 2<sup>nd</sup> interaction point of NICA collider.
- The SPD Muon Range System being based on the Mini-Drift Tubes as a detector and iron plates as absorber, followed by a robust analogue amplifier/discriminator technique supplemented by a digital end-stage for data transfer to the DAQ are up to its tasks:
  - identify the primary muons;
  - perform optimal separation from background contamination;
  - perform hadron calorimetry;
  - identify neutrons.

**Thank you!**